

**JUMO GmbH & Co. KG**  
Delivery address: Mackenrodtstraße 14,  
36039 Fulda, Germany  
Postal address: 36035 Fulda, Germany  
Phone: +49 661 6003-0  
Fax: +49 661 6003-607  
e-mail: mail@jumo.net  
Internet: www.jumo.net

**JUMO Instrument Co. Ltd.**  
JUMO House  
Temple Bank, Riverway  
Harlow, Essex CM20 2DY, UK  
Phone: +44 1279 635533  
Fax: +44 1279 635262  
e-mail: sales@jumo.co.uk  
Internet: www.jumo.co.uk

**JUMO Process Control, Inc.**  
8 Technology Boulevard  
Canastota, NY 13032, USA  
Phone: 315-697-JUMO  
1-800-554-JUMO  
Fax: 315-697-5867  
e-mail: info@jumo.us  
Internet: www.jumo.us



## JUMO Etemp B

### Screw-in RTD temperature probe with connection head form B for standard applications

- Temperature range from -50 to +400 °C
- With built-in measuring insert
- As single or double RTD temperature probes
- Terminal head form B or BUZ
- Available with transmitter

#### Brief description

Screw-in RTD temperature probes for standard applications are preferentially used for measuring temperatures in liquids and gases. A decisive selection criterion is the reliable sealing feature of this installation type with vacuum and with overpressure. The application areas are, among others, in the air conditioning technology and refrigeration engineering as well as the HVAC and apparatus engineering sector.

The connection head is suitable for ambient temperatures up to +100 °C. In addition to the standard connection head form B, design BUZ is also available.

The measuring insert is normally fitted with a Pt100 temperature sensor according to DIN EN 60751, Class B in 2-wire circuit; versions with Pt500 or Pt1000 temperature sensors can also be supplied, as well as 4-wire circuit connections. A transmitter can be optionally integrated into the connection head.

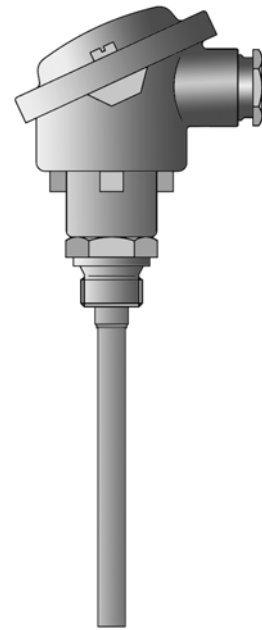

Basic type 902023/10

### Technical data

<b>Terminal head</b>	Form B DIN EN 50446, die-cast aluminum, M 20x1.5; IP65, ambient temperature -40 to +100 °C Form BUZ, die-cast aluminum, M 20x1.5; IP65, ambient temperature -40 to +100 °C Reduced ambient temperature when using transmitters, data sheet 707030 and 707010
<b>Process connection</b>	thread, stainless steel 1.4571
<b>Sheath</b>	Stainless steel 1.4571, Ø 6 mm, Ø 8 mm
<b>Measuring insert</b>	Pt100 temperature sensor DIN EN 60751, cl. B, 2-wire circuit, built-in
<b>Response times</b>	$t_{0,5} = 5 \text{ s}$ , $t_{0,9} = 14 \text{ s}$ in water 0.4 m/s; Ø 6 mm
<b>Transmitter</b>	Analog transmitter, output 4 to 20 mA, data sheet 707030 Analog transmitter, output 0 to 10 V, data sheet 707030 Programmable transmitter, output 4 to 20 mA/20 to 4 mA, data sheet 707010
<b>Accessories</b>	sheath, data sheet 909710

**JUMO GmbH & Co. KG**  
 Delivery address: Mackenrodtstraße 14,  
 36039 Fulda, Germany  
 Postal address: 36035 Fulda, Germany  
 Phone: +49 661 6003-0  
 Fax: +49 661 6003-607  
 e-mail: mail@jumo.net  
 Internet: www.jumo.net

**JUMO Instrument Co. Ltd.**  
 JUMO House  
 Temple Bank, Riverway  
 Harlow, Essex CM20 2DY, UK  
 Phone: +44 1279 635533  
 Fax: +44 1279 635262  
 e-mail: sales@jumo.co.uk  
 Internet: www.jumo.co.uk

**JUMO Process Control, Inc.**  
 8 Technology Boulevard  
 Canastota, NY 13032, USA  
 Phone: 315-697-JUMO  
 1-800-554-JUMO  
 Fax: 315-697-5867  
 e-mail: info@jumo.us  
 Internet: www.jumo.us



## Dimensions

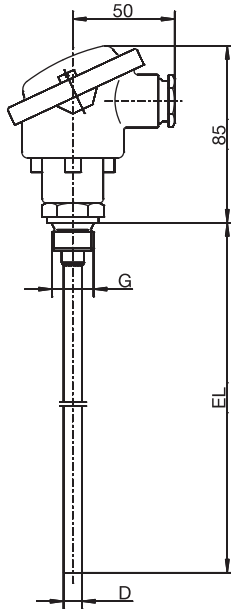

Basic type 902023/10

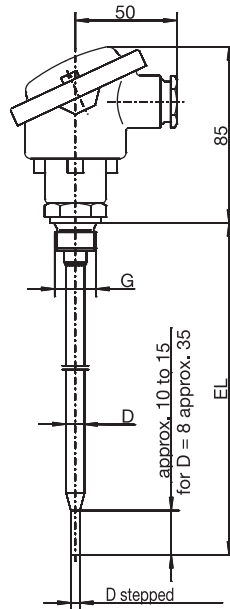

Basic type 902023/11

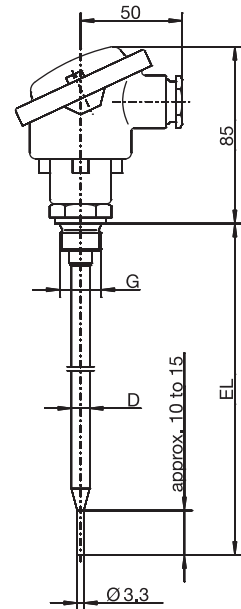

Basic type 902023/31

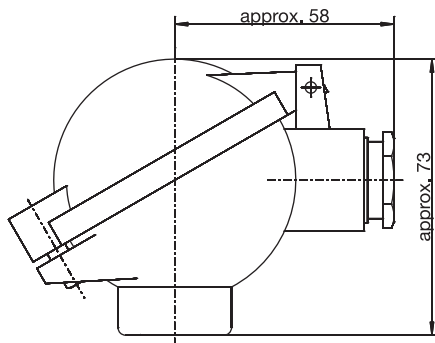

terminal head Form BUZ  
 Extra code 320

**JUMO GmbH & Co. KG**  
 Delivery address: Mackenrodtstraße 14,  
 36039 Fulda, Germany  
 Postal address: 36035 Fulda, Germany  
 Phone: +49 661 6003-0  
 Fax: +49 661 6003-607  
 e-mail: mail@jumo.net  
 Internet: www.jumo.net



**JUMO Instrument Co. Ltd.**  
 JUMO House  
 Temple Bank, Riverway  
 Harlow, Essex CM20 2DY, UK  
 Phone: +44 1279 635533  
 Fax: +44 1279 635262  
 e-mail: sales@jumo.co.uk  
 Internet: www.jumo.co.uk

**JUMO Process Control, Inc.**  
 8 Technology Boulevard  
 Canastota, NY 13032, USA  
 Phone: 315-697-JUMO  
 1-800-554-JUMO  
 Fax: 315-697-5867  
 e-mail: info@jumo.us  
 Internet: www.jumo.us

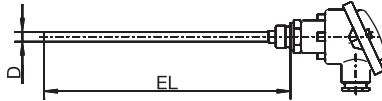
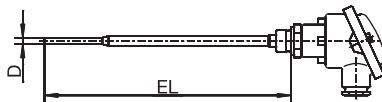

## Order details

### (1) Basic type

902023/10	JUMO Etemp B Screw-in RTD temperature probes with terminal head form B and with continuous sheath	
902023/11	JUMO Etemp B Screw-in RTD temperature probes with terminal head form B and with stepped sheath (for Ø 6 mm on Ø 3.8 mm/for Ø 8 mm on Ø 6 mm)	
902023/31	JUMO Etemp B Screw-in RTD temperature probes with terminal head form B and with stepped sheath for air measurement	

### (2) Operating temperature in °C

x x x	380	-50 to +200 °C (standard)
x x	386	-50 to +260 °C
x x	402	-50 to +400 °C
x x	647	-20 to +150 °C (only in connection with class B and 1x Pt100 in 2-wire circuit)

### (3) Measuring insert

x x x	1003	1x Pt100 in 2-wire circuit
x x x	1011	1x Pt100 in 4-wire circuit
x x x	2003	2x Pt100 in 2-wire circuit

### (4) Tolerance class as per DIN EN 60751

x x x	1	Class B (standard)
x x x	2	Class A
x x x	3	Class AA (1/3 DIN B)

### (5) Sheath diameter D in mm

x x x	6	Ø 6 mm
x x	8	Ø 8 mm

### (6) Fitting length EL in mm (EL 50 to 1000 mm, max. 800 mm for basic types 902023/11 and 902023/31)

x	50	50 mm
x x x	100	100 mm
x x x	200	200 mm
x x x	...	Please specify in plain text (50 mm steps)

### (7) Process connection

x x x	102	Screw connection G 1/4
x x x	103	Screw connection G 3/8
x x x	104	Screw connection G 1/2
x x x	126	Screw connection M 18x1.5
x x x	128	Screw connection M 20x1.5
x x x	144	Screw connection (thread) 1/2-14NPT

**JUMO GmbH & Co. KG**  
 Delivery address: Mackenrodtstraße 14,  
 36039 Fulda, Germany  
 Postal address: 36035 Fulda, Germany  
 Phone: +49 661 6003-0  
 Fax: +49 661 6003-607  
 e-mail: mail@jumo.net  
 Internet: www.jumo.net

**JUMO Instrument Co. Ltd.**  
 JUMO House  
 Temple Bank, Riverway  
 Harlow, Essex CM20 2DY, UK  
 Phone: +44 1279 635533  
 Fax: +44 1279 635262  
 e-mail: sales@jumo.co.uk  
 Internet: www.jumo.co.uk

**JUMO Process Control, Inc.**  
 8 Technology Boulevard  
 Canastota, NY 13032, USA  
 Phone: 315-697-JUMO  
 1-800-554-JUMO  
 Fax: 315-697-5867  
 e-mail: info@jumo.us  
 Internet: www.jumo.us



			(8) Extra codes
x	x	x	000 none
x	x	x	320 terminal head Form BUZ
x	x	x	330 1x transmitter, analog output 4 to 20 mA <sup>a</sup> , data sheet 707030
x	x	x	331 1x programmable transmitter, 4 to 20 mA output <sup>b</sup> , data sheet 707010
x	x	x	333 1x transmitter, analog output 0 to 10 V <sup>a</sup> , data sheet 707030

<sup>a</sup> Specify measuring range in plain text.

<sup>b</sup> Specify measuring range and output signal in plain text.

Order code	(1)	(2)	(3)	(4)	(5)	(6)	(7)	(8)	, ... <sup>a</sup>
Order example	902023/10	- 380	- 1003	- 1	- 6	- 100	- 104	/ 000	

<sup>a</sup> State extra codes one after another, separated by commas.

## Stock versions

(1)	(2)	(3)	(4)	(5)	(6)	(7)	(8)	Sales No.:
902023/10	- 380	- 1003	- 1	- 6	- 100	- 104	/ 000	90/00543945
902023/10	- 380	- 1003	- 1	- 6	- 150	- 104	/ 000	90/00542800
902023/10	- 380	- 1003	- 1	- 6	- 300	- 104	/ 000	90/00542801
902023/10	- 402	- 1003	- 1	- 6	- 100	- 104	/ 000	90/00543946
902023/10	- 402	- 1003	- 1	- 6	- 150	- 104	/ 000	90/00542802
902023/10	- 402	- 1003	- 1	- 6	- 300	- 104	/ 000	90/00542803
902023/10	- 402	- 1003	- 1	- 6	- 100	- 104	/ 331(0 to 100 °C)	90/00544265
902023/31	- 380	- 1003	- 1	- 6	- 250	- 104	/ 000	90/00542804