

JUMO GmbH & Co. KG

Delivery address: Mackenrodtstraße 14
36039 Fulda, Germany
Postal address: 36035 Fulda, Germany
Phone: +49 661 6003-0
Fax: +49 661 6003-607
E-mail: mail@jumo.net
Internet: www.jumo.net

JUMO Instrument Co. Ltd.

JUMO House
Temple Bank, Riverway
Harlow, Essex CM20 2DY, UK
Phone: +44 1279 635533
Fax: +44 1279 635262
E-mail: sales@jumo.co.uk
Internet: www.jumo.co.uk

JUMO Process Control, Inc.

6733 Myers Road
East Syracuse, NY 13057, USA
Phone: 315-437-5866
1-800-554-5866
Fax: 315-437-5860
E-mail: info.us@jumo.net
Internet: www.jumousa.com



Contact Thermometer

Transformer and industry version

Special features

- Class 1.5
- Display ranges -40° C to +600° C
- Electromechanical temperature controller as add-on device with actual value indicator in polyamide (PA6) case
- With one or two microswitches
- Case size: Ø 80 mm

Brief description

The contact thermometer is a universal device with actual value display for temperature measurement, control and monitoring.

The temperature-dependent volume change in a measuring system filled with liquid or the temperature-dependent pressure change in a measuring system filled with gas is converted to a rotational movement of the actual value indicator by a bourdon tube; no transmission gear is required. The microswitch is actuated by the rotational movement of the indicator shaft via a tap system.



Type 608540/1080

JUMO GmbH & Co. KG
 Delivery address: Mackenrodtstraße 14
 36039 Fulda, Germany
 Postal address: 36035 Fulda, Germany
 Phone: +49 661 6003-0
 Fax: +49 661 6003-607
 E-mail: mail@jumo.net
 Internet: www.jumo.net

JUMO Instrument Co. Ltd.
 JUMO House
 Temple Bank, Riverway
 Harlow, Essex CM20 2DY, UK
 Phone: +44 1279 635533
 Fax: +44 1279 635262
 E-mail: sales@jumo.co.uk
 Internet: www.jumo.co.uk

JUMO Process Control, Inc.
 6733 Myers Road
 East Syracuse, NY 13057, USA
 Phone: 315-437-5866
 1-800-554-5866
 Fax: 315-437-5860
 E-mail: info.us@jumo.net
 Internet: www.jumousa.com



Technical data

Case, bezel, and cover cap	Plastic (PA 6), gray, UV-stabilized		
Protection type	IP 54 according to DIN EN 60529		
Front pane	PMMA (Plexiglas)		
Scale	White, with black lettering		
Accuracy class	Class 1.5 similar to EN 13190		
	Liquid filling	Gas filling	
Measuring system	Display range (AB) ≤ 350°C	Display range (AB) ≥ 400°C	
Time constant $t_{0.632}$	Approx. 12 s, measured in water, with a probe Ø of 6 mm made of Cu.	Approx. 4 s, measured in oil, with a probe Ø of 10 mm made of stainless steel.	
Influential effect of the ambient temperature	In % of the display range (referring to the deviation from the reference value +23°C)		
On case	0.15% of the display range per K ambient temperature change	0.05% of the display range per K ambient temperature change	
On capillary (per m)	0.03% of the display range per K ambient temperature change	No influence	
	At higher ambient temperature – higher temperature display – lower switching point		
	Standard	Extra code (TZ) 650	
Electrical contact	Single-pole microswitch with mechanically actuated changeover contact		
Contact type			
Switching capacity	AC 230V, +10/-15%, 48 to 63Hz, cos φ = 1 (0.6)		
	5 (1.5) A	10 (3) A	
Switching differential	Approx. 1.5% of the display range	1.5 to 3 % of the display range	
Switching point accuracy	± 0.5% of the display range referring to the switch-off point with rising temperature		
Switching reliability	To ensure a high switching reliability, we recommend a minimum voltage of 24 V and a minimum current of 20 mA		
Electrical connection	Screw terminals: conductor cross-section 2.5 mm ² , protected by cover cap with cable fitting. Suitable for cable diameter from 6.5 to 16 mm.		
Setpoint value adjustment	With a screwdriver, protected by a cover.		
Limit value temperatures	-30 to +70°C (storage and transport -30 to +70°C)		
Rated position (NL)	NL90, position symbol ⊥		
Display range (AB)	Display range in °C	Measuring range in °C	Tolerance in °C (+/-)
469	-40 to +40	-30 to +30	1.5
643	-20 to +120	0 to +100	3.0
807	0 to +60	+10 to +50	1.5
814	0 to +100	+10 to +90	1.5
818	0 to +120	+20 to +100	3.0
832	0 to +200	+20 to +180	3.0
840	0 to +300	+30 to +270	6.0
848	0 to +400	+50 to +350	6.0
854	0 to +500	+50 to +450	8.0
858	0 to +600	+100 to +500	10.0

JUMO GmbH & Co. KG
 Delivery address: Mackenrodtstraße 14
 36039 Fulda, Germany
 Postal address: 36035 Fulda, Germany
 Phone: +49 661 6003-0
 Fax: +49 661 6003-607
 E-mail: mail@jumo.net
 Internet: www.jumo.net

JUMO Instrument Co. Ltd.
 JUMO House
 Temple Bank, Riverway
 Harlow, Essex CM20 2DY, UK
 Phone: +44 1279 635533
 Fax: +44 1279 635262
 E-mail: sales@jumo.co.uk
 Internet: www.jumo.co.uk

JUMO Process Control, Inc.
 6733 Myers Road
 East Syracuse, NY 13057, USA
 Phone: 315-437-5866
 1-800-554-5866
 Fax: 315-437-5860
 E-mail: info.us@jumo.net
 Internet: www.jumousa.com



Dimensions

Type 608540/0280

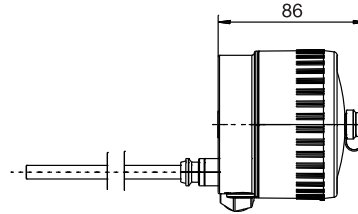
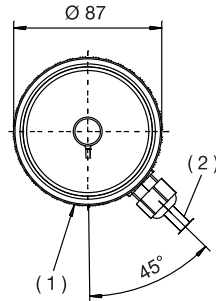

- (1) Ventilation aperture
- (2) Connecting cable, 0.5 m long

Type 608540/1080
 (Transformer version)

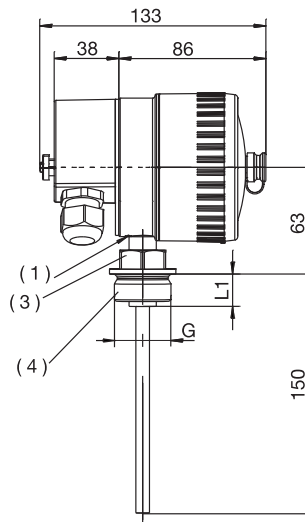
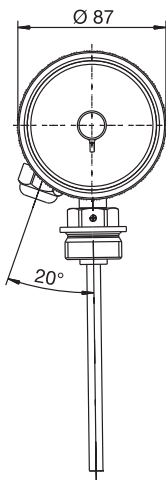

G 1/2 A	27	14
G 3/4A	32	16
G 1A	27	16
G	Width across flats	L1

- (1) Ventilation aperture
- (3) Width across flats
- (4) Screw-in spigot DIN 3852, form A

Type 608540/2280

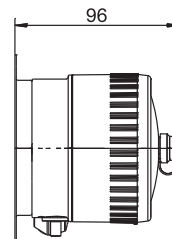
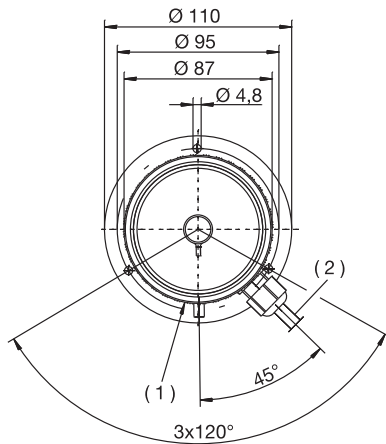

- (1) Ventilation aperture
- (2) Connecting cable, 0.5 m long

Type 608540/2380

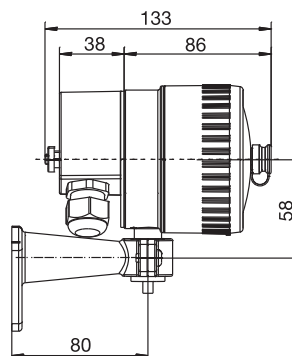
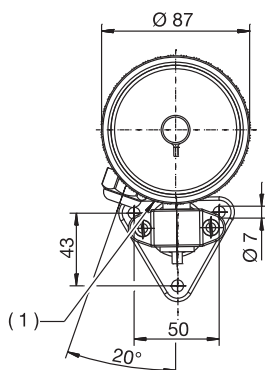

- (1) Ventilation aperture

JUMO GmbH & Co. KG
 Delivery address: Mackenrodtstraße 14
 36039 Fulda, Germany
 Postal address: 36035 Fulda, Germany
 Phone: +49 661 6003-0
 Fax: +49 661 6003-607
 E-mail: mail@jumo.net
 Internet: www.jumo.net



JUMO Instrument Co. Ltd.
 JUMO House
 Temple Bank, Riverway
 Harlow, Essex CM20 2DY, UK
 Phone: +44 1279 635533
 Fax: +44 1279 635262
 E-mail: sales@jumo.co.uk
 Internet: www.jumo.co.uk

JUMO Process Control, Inc.
 6733 Myers Road
 East Syracuse, NY 13057, USA
 Phone: 315-437-5866
 1-800-554-5866
 Fax: 315-437-5860
 E-mail: info.us@jumo.net
 Internet: www.jumousa.com

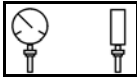
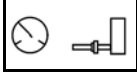

Order details:

Contact thermometer, type 608540

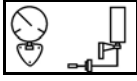
Order code:	(1) Basic type	
608540	Mechanical contact thermometer, industrial version	
	(2) Basic type extension	
1080	Design type: 10; case size: \varnothing 80 mm	
0280	Design type: 02; case size: \varnothing 80 mm	
2280	Design type: 22; case size: \varnothing 80 mm	
2380	Design type: 23; case size: \varnothing 80 mm	
	(3) Display range in °C	
469	-40 to +40	
643	-20 to +120	
807	0 to +60	
814	0 to +100	
818	0 to +120	
832	0 to +200	
840	0 to +300	
848	0 to +400	
854	0 to +500	
858	0 to +600	
	(4) Capillary type (FL)¹	
00	Without (with rigid connection)	
02	FL 02 Cu capillary with Cu textile braiding, approx. \varnothing 2.5 mm (up to AB end value +300°C)	
11	FL 11 Cu capillary with PE coating, approx. \varnothing 3.5 mm (up to AB end value +120°C)	
17	FL 17 Stainless steel capillary, \varnothing 1.5 mm	
21	FL 21 Cu capillary, \varnothing 1.0 mm (up to AB end value +300°C)	
	(5) Capillary length¹	
0	Without (with rigid connection)	
1000	1000 mm	
2000	2000 mm	
3000	3000 mm	
4000	4000 mm	
5000	5000 mm	
...	Special length (specifications in plain text: 1,000 mm increments, maximum length 10,000 mm)	

JUMO GmbH & Co. KG
 Delivery address: Mackenrodtstraße 14
 36039 Fulda, Germany
 Postal address: 36035 Fulda, Germany
 Phone: +49 661 6003-0
 Fax: +49 661 6003-607
 E-mail: mail@jumo.net
 Internet: www.jumo.net

JUMO Instrument Co. Ltd.
 JUMO House
 Temple Bank, Riverway
 Harlow, Essex CM20 2DY, UK
 Phone: +44 1279 635533
 Fax: +44 1279 635262
 E-mail: sales@jumo.co.uk
 Internet: www.jumo.co.uk

JUMO Process Control, Inc.
 6733 Myers Road
 East Syracuse, NY 13057, USA
 Phone: 315-437-5866
 1-800-554-5866
 Fax: 315-437-5860
 E-mail: info.us@jumo.net
 Internet: www.jumousa.com



Order details:

Contact thermometer, type 608540.

Order code:	(6) Process connection (PC)¹	
750	TF 01; Temperature probe with stepped support tube	
752	TF 11; Temperature probe without support tube	
843	TA 02; Protection tube with union nut and loose screw connection ²	
161	TA 03; Protection tube with loose union nut	
847	TA 06; Displaceable threaded fitting on support tube ²	
311	TA 20; Protection tube with loose screw connection and connection collar ²	
872	TA 21; Protection tube with loose pressure screw and conical seal	
873	TA 22; Protection tube with loose pressure screw, conical seal, and loose screw connection ²	
401	TA 23; Protection tube with pressure screw and contact pressure spring	
874	TA 24; Protection tube (CuNi) with screw connection (CuZn), O ring seal and clamping screw ^{2, 5}	
913	SH 07; Screw-in sleeve, multi-sectional, with clamping piece and fixing screw ² (with TF 01)	
820	SH 09; Weld-in sleeve, multi-sectional, with clamping piece and fixing screw (not with FL 21 – weld collar with steel 1.4515) (with TF 01)	
876	SH 10; Screw-in sleeve, multi-sectional ²	
871	SH 11; Screw-in sleeve, multi-sectional ²	
	(7) Diameter of process connection (PC)¹	
6	Ø 6 mm	
8	Ø 8 mm	
10	Ø 10 mm	
12	Ø 12 mm	
	(8) Thread type of process connection (PC)¹	
000	Without thread (for TF 01 and TF 11)	
103	Screw connection G ³ / ₈	
104	Screw connection G ¹ / ₂	
105	Screw connection G ³ / ₄	
106	Screw connection G1	
114	Screw connection M 10 × 1 (only for TA 23 and SH 11)	
	(9) Material, probe / support tube¹	
26	Stainless steel (CrNi, 1.4571)	
96	Copper (Cu) / Brass (CuZn) (up to 200°C)	
95	Stainless steel (CrNi, 1.4571) – probe / brass (CuZn) – support tube (from 250°C)	
	(10) Material of process connection (PC)¹	
00	Without (only TF 01 and TF 11)	
26	Stainless steel (CrNi, 1.4571)	
46	Brass (CuZn)	
	(11) Insertion length, process connection (PC)¹ (dimension "EL" or "S")	
0	Minimum insertion length TF 11 (active probe dimension)	
100	100 mm	
150	150 mm	
200	200 mm	
...	Special length (specifications in plain text – 50 mm increments)	

JUMO GmbH & Co. KG
 Delivery address: Mackenrodtstraße 14
 36039 Fulda, Germany
 Postal address: 36035 Fulda, Germany
 Phone: +49 661 6003-0
 Fax: +49 661 6003-607
 E-mail: mail@jumo.net
 Internet: www.jumo.net

JUMO Instrument Co. Ltd.
 JUMO House
 Temple Bank, Riverway
 Harlow, Essex CM20 2DY, UK
 Phone: +44 1279 635533
 Fax: +44 1279 635262
 E-mail: sales@jumo.co.uk
 Internet: www.jumo.co.uk

JUMO Process Control, Inc.
 6733 Myers Road
 East Syracuse, NY 13057, USA
 Phone: 315-437-5866
 1-800-554-5866
 Fax: 315-437-5860
 E-mail: info.us@jumo.net
 Internet: www.jumousa.com



Order details:

Contact thermometer, type 608540

Order code: **(12) Switching output**

20 1 switch

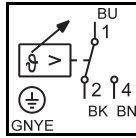

21 2 switches

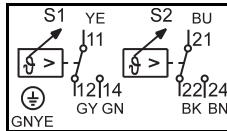

22 2 switches in fixed sequence

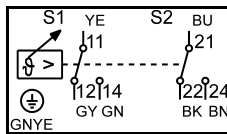

(13) Extra codes (TZ)

000 Without extra code
 430 Drag indicator
 650 Microswitch 10 (3) A (AC/DC 230 V, +10/-15%, 48 to 63 Hz, cos φ = 1 (0.6))
 518 Stop for Min. — or Max. — setpoint value limitation, default setting
 522 Customized scale

Order code:

(1) (2) (3) (4) (5) (6) (7) (8) (9) (10) (11) (12) (13)
 608540 / [] - [] - [] - [] - [] - [] - [] - [] - [] - [] - [] - [] / [] , ...

Order example:

608540 / [2280] - [818] - [02] - [2000] - [843] - [8] - [104] - [96] - [46] - [100] - [20] / [000]³

¹ For description and special features refer to data sheet 608730.
² Screw-in spigot according to DIN 3852 form A.
³ List extra codes in sequence, separated by commas.
⁴ Not with design types 02 and 10.
⁵ Material, probe / support tube: design types 02 and 10: stainless steel
 design types 22 and 23: brass

Stock versions

(Delivery within 3 working days after receipt of order)

Transformer version

Sales no.	Type	Display range °C / °F	Switching output (SA)	Temperature probe Process connection	Protection tube "S"
60/00491256	608540/1080-643-00-0-874-8-106-26-46-150-21/430, 522, 477 with drag indicator	-20 to +120°C	21	TA 24, G1" CuZn	150 mm
60/00512083	608540/1080-643-00-0-874-8-106-26-46-150-20/430, 522, 477 with drag indicator		20 1 switch		