



JUMO dTRANS pH 02

Transmitter/controller for pH, redox, ammonia, standard signals and temperature

Brief description

The JUMO dTRANS pH 02 is a compact, modular instrument. It is highly flexible (for example 3 slots for optional boards) and capable of performing a wide range of tasks. The main input of the JUMO dTRANS pH 02 is designed for sensors used to measure the pH value or redox potential (both conventional glass sensors and ISFET sensors can be connected) or ammonia concentration. Resistance thermometers Pt100 and Pt1000, NTC/PTC or standard signals 0(4) - 20 mA or 0 - 10 V can be connected to the second analog input (compensation input). The two binary inputs can be used either as initiators for actions (e.g. HOLD, keyboard inhibit) or when connecting pulse generators (for example impeller sensors) for flow-rate measurement. The high-contrast graphic display allows for several options including display of input signal with numbers or as bar graph. Parameters are displayed in plain text for easily comprehensible and reliable operation.

The JUMO dTRANS pH 02 can be used as a two-point or three-point controller, three-point modulating controller or continuous controller. All controller outputs can be configured to P, PI, PD or PID action. The software for the controllers includes parameter set selection, a math module and more.

A setup program is available for convenient configuration via PC. The instrument can be integrated into a data network by means of an RS422/485 or PROFIBUS-DP interface. Screw terminals on the back are used for the electrical connection.

Some applications:

- Neutralization
- Detoxification applications (parameter set selection)
- Redundant pH measurement with one instrument
- pH measurement including flow-rate measurement
- pH measurement including measurement of free chlorine (pH compensated chlorine measurement).

Block diagram

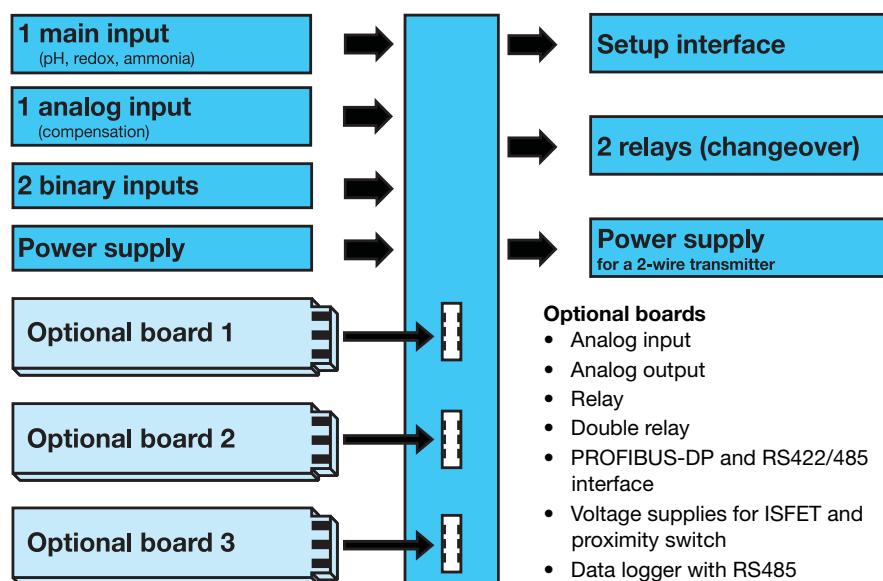

Approval/Approval marks (see Technical data)



JUMO dTRANS pH 02, type 202551/01... in panel case



JUMO dTRANS pH 02, type 202551/05... in surface-mounted case

Key features

- A choice of display visualizations: large numbers, bar graph or trend display
- Integrated calibration routines: with 1, 2 and 3 points
- Math and logic module
- Calibration logbook
- Wash timer to control cleaning equipment
- 13 operator languages integrated; see order details
- Setup program provides: convenient programming, system documentation
- Flush-mounted instrument - just 96 mm x 48 mm x 95 mm
- Electrode monitoring can be activated
- Flow-rate measurement

JUMO GmbH & Co. KG
 Delivery address: Mackenrodtstraße 14
 36039 Fulda, Germany
 Postal address: 36035 Fulda, Germany
 Phone: +49 661 6003-0
 Fax: +49 661 6003-607
 Email: mail@jumo.net
 Internet: www.jumo.net

JUMO Instrument Co. Ltd.
 JUMO House
 Temple Bank, Riverway
 Harlow, Essex CM 20 2DY, UK
 Phone: +44 1279 63 55 33
 Fax: +44 1279 62 50 29
 Email: sales@jumo.co.uk
 Internet: www.jumo.co.uk

JUMO Process Control, Inc.
 6733 Myers Road
 East Syracuse, NY 13057, USA
 Phone: +1 315 437 5866
 Fax: +1 315 437 5860
 Email: info.us@jumo.net
 Internet: www.jumousa.com



Boards

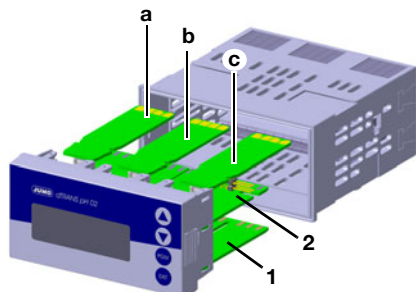

(1)	PSU board
(2)	Main board
(a)	Optional board 1
(b)	Optional board 2
(c)	Optional board 3

PSU board (1)

This board is always fitted in the instrument and no variations are possible.

The board includes the following items:

- The voltage supply for the JUMO dTRANS pH 02.
- The voltage supply for external 2-wire transmitters.
- 2 relays with changeover contacts.

Main board (2)

This board can **not** be changed subsequently! The main board (pH/redox) has:

- The main input for connecting a pH, redox or ammonia electrode.
- The secondary input for connecting a temperature sensor Pt100, Pt1000, a resistance transmitter or a standard signal 0(4) to 20 mA or 0 to 10 V.
- 2 binary inputs.
- The setup interface (for PC interface adapter).

Optional board (1), (2) or (3)

These boards are combinable and can be ordered in the following versions:

- Analog input
- 1 continuous output
- 1 relay (changeover)
- 2 relays (NO with common pin)
- 1 Triac (1 A)
- 1 PhotoMOS® relay (0.2 A)
- 1 voltage supply for an ISFET sensor (4.85 V)

The following boards can **only** be placed in slot 3, either:

- Modbus/Jbus
- PROFIBUS-DP
- Data logger

For versions with a wall-mounted case the (re)placement of the optional boards by the customer is not possible.

Functional description

The instrument is a modularly designed indicator/controller for use in both simple and demanding control tasks. It can be integrated into the PLC via interfaces

To make programming and operation easy, all parameters are clearly assigned to levels and displayed in plain text. Operation is protected by a code word. Operation can be adapted on an individual basis because parameters can be generally enabled or assigned to the protected area.

A setup program for the PC is available as a more convenient configuration option, rather than using the instrument keypad.

User data



Up to 8 parameters that are frequently changed by the user can be combined in the user level under "User data" (via setup program only).

Displays and controls

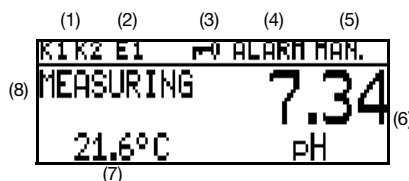

(1)	Binary outputs (relays) Output active if symbol is visible.
(2)	Binary input Input closed if symbol is visible.
(3)	Keyboard inhibit Keys locked if symbol is visible.
(4)	Alarm message ALARM (flashing): Broken sensor or overrange, etc. AL R1: Controller monitoring alarm from controller channel 1. AL R2: Controller monitoring alarm from controller channel 2. CALIB: Calibration mode active. CALIB (flashing): Calibration timer elapsed.
(5)	Output mode MAN.: Manual mode active. HOLD: Hold mode active.
(6)	Upper display Measured value and unit of the variable set by parameter "Upper display".

(7)	Lower display Measured value and unit of the variable set by parameter "Lower display".
(8)	Operating mode MEASUREMENT: Normal measuring mode is active.

Display modes

The following display modes are available:

Normal display

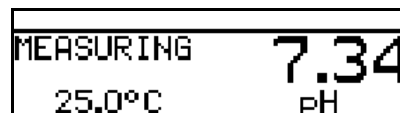

In this display method the measurements appear in numbers, as usual.

Large display



This method uses the complete display height.

Trend display

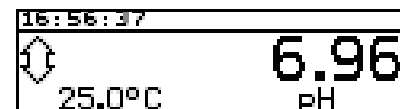

In this display a symbol is added to the numerical value to indicate the direction and speed of change for the measurement value. This can be very useful for optimizing the controller, for example.
 From left to right:
 Fast, medium and slow rise, steady, slow, medium and fast fall.

Bar graph



In this display mode, it only takes a glance to ascertain the range for the current measurement.

Any scale can be used for the bar graph.

Trend curve (data monitor)



The ring buffer contains about 100 measuring points. The sampling and storage rates can be adjusted.

JUMO GmbH & Co. KG
 Delivery address: Mackenrodtstraße 14
 36039 Fulda, Germany
 Postal address: 36035 Fulda, Germany
 Phone: +49 661 6003-0
 Fax: +49 661 6003-607
 Email: mail@jumo.net
 Internet: www.jumo.net

JUMO Instrument Co. Ltd.
 JUMO House
 Temple Bank, Riverway
 Harlow, Essex CM 20 2DY, UK
 Phone: +44 1279 63 55 33
 Fax: +44 1279 62 50 29
 Email: sales@jumo.co.uk
 Internet: www.jumo.co.uk

JUMO Process Control, Inc.
 6733 Myers Road
 East Syracuse, NY 13057, USA
 Phone: +1 315 437 5866
 Fax: +1 315 437 5860
 Email: info.us@jumo.net
 Internet: www.jumousa.com



Flow rate quantity

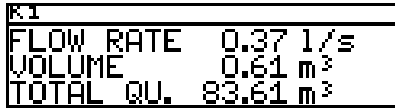

If an input has been configured for flow-rate measurement, this display can be accessed.

Function modes of the main board

pH measurement

Both pH combination electrodes and glass electrodes with separate reference electrode can be connected. There are two ways to connect these measurement chains:

- Asymmetrical high-resistance (the variant generally used)
- Symmetrical high-resistance (connection type used in special cases)

The impedance of the connected electrode can be monitored. The glass and reference impedance can be recorded individually (when a separate ground pin is used) or as a cumulative value.

Special electrodes, for example antimony electrodes, can also be connected.

The instrument makes a voltage supply available for ISFET sensors. This makes it possible to operate the corresponding sensors directly.

ISFET sensors are used in special applications when there is a preference not to use glass sensors (e.g. non-glass pH value measurement). Because these sensors are not standardized, usability should be checked before they are used.

The temperature of the pH value is compensated by means of the automatic temperature measurement by the second input or by entering the value manually.

Redox measurement

Both redox combination electrodes and metal electrodes with separate reference electrode can be connected.

The display can be in mV or any scale can be used.

Ammonia measurement

After the instrument is configured as an NH₃ (ammonia) transmitter/controller, the corresponding sensors can be connected.

Ammonia measurements are required for example in leakage monitoring of cooling circuits.

Analog input for main board

0(4) to 20 mA; 0 to 10 V and Pt100/Pt1000/NTC/PTC (max. 30 kΩ)/customized.

Typical application: Compensation input for temperature compensation of the main measurement variable.

Function modes of the option inputs, multi-channel mode

If analog inputs have been fitted (optional board), the device will have multi-channel functions. The following signal types can be processed:

- 0(4) to 20 mA
- 0 to 10 V
- Pt100/Pt1000

Sensors that return one of the output signals listed above can be connected to the instrument for the following measurement variables, for example:

- free chlorine, chlorine dioxide, ozone, hydrogen peroxide and peracetic acid as per data sheet 202630.
- pH value or redox potential as per data sheet 202705.
- liquid level measurements.
- flow rate measurements etc.

The instrument provides the following calibration options in this function mode:

- Zero point
- End value
- Zero point and end value
- Cell constant
- Temperature coefficient

This allows optimum adaptation of the instrument to the sensor.

Linear scaling

Select this mode when the input signal will be displayed linearly.

One of the following units is used for display or control:

- µS/cm
- mS/cm
- %
- mV
- pH
- ppm
- customized (5 characters)

Electrolytic conductivity

µS/cm or mS/cm are the units used for display and control.

Specific resistance (ultra-pure water)

Display/control with the unit kΩ × cm or MΩ × cm.

TDS

Display/control with the unit ppm.

The specific TDS factor can also be entered in this mode.

Concentration

In this mode, the concentration of a liquid can be determined from its uncorrected conductivity.

% or "customized" are the units used for display and control.

Concentration measurement:

Caustic solution

- NaOH 0 to 15 % by wt. 0 to 90 °C
- NaOH 25 to 50 % by wt. 0 to 90 °C

Nitric acid

- HNO₃ 0 to 25 % by wt. 0 to 80 °C
- HNO₃ 36 to 82 % by wt. -20 to 80 °C

Sulfuric acid

- H₂SO₄ 0 to 28 % by wt. 0 to 100 °C
- H₂SO₄ 36 to 85 % by wt. 0 to 115 °C
- H₂SO₄ 92 to 99 % by wt. 0 to 115 °C

Hydrochloric acid

- HCl 0 to 18 % by wt. 0 to 65 °C
- HCl 22 to 44 % by wt. -20 to 65 °C

Customized with table

Non-linear correlations between the input and output variable can be processed in this mode. Typical applications include measuring the level of liquid in horizontal, cylindrical containers or simply measuring the concentration.

The input values are processed in a table (max. 20 value pairs). Values can only be entered in the table using the optional setup program.

The units used for display and control are:

- µS/cm
- mS/cm
- customized (5 characters)
- Use the offset parameter to adjust the display.

Calibration

pH value measurement

- One-point calibration
- Two-point calibration
- Three-point calibration

Redox potential measurement

- One-point calibration with display in mV
- Two-point calibration with display in % (free scaling)

NH₃ (ammonia) measurement

- One-point calibration (zero point of the measurement chain)

Calibration logbook

The last five successful calibrations can be accessed from the calibration logbook. This makes it possible to evaluate the aging of the connected sensor.

The logbook can be deleted if necessary (useful when changing the sensor).

If a data logger has been fitted (optional board), additional information such as the date and time are documented.



Calibration timer

The calibration timer indicates (on request) a required routine calibration. The calibration timer is activated by entering the number of days that must expire before there is a scheduled re-calibration (specified by the system or the operator).

Additional functions of the JUMO dTRANS pH 02

Min/max value memory

This memory records the minimum and maximum input quantities that occur. This information can be used, for example, to assess whether the design of the connected sensor is suitable for the values that actually occur.

Binary input

The following functions can be accessed through the binary input:

- Key lock activation
 When this function is activated, operation is no longer possible via the keypad.
- "HOLD" mode activation
 When this function is activated, the outputs (analog and relay) adopt the states previously defined.
- Alarm suppression (controller alarm only)
 This function is used to temporarily deactivate alarm generation by means of the appropriately configured relay.
- Flow-rate measurement (counting input)
 Instantaneous value
 Partial quantity
 Total quantity

Bridging the corresponding connection terminals with a floating contact (for example a relay) activates a predefined function.

Wash timer

A software function can be used to trigger cyclically recurring actions by controlling a relay.

Control functions

Functions can be assigned to the relays. The functions can be configured in turn by parameters P, PI, PD and PID structures can be freely programmed as control functions.

Relay outputs

Two relay changeover contacts are available for the main measurement variable and/or the temperature.

The following functions can be programmed:

- Switching direction (min/max)
- Limit controller (energizing/deenergizing delay, hysteresis)
- Pulse length output (see control functions)

- Pulse frequency output (see control functions)
- Modulating function (see control functions)
- Pulse controls
 With this function, the output briefly switches on when the switching point is reached and then switches off again
- Wash timer elapsed
- Alarm
- Sensor/range error
- Behavior in the event of an alarm, underrange or overrange measurement, calibration and "HOLD"

Flow-rate measurement

Flow rate transmitters can be connected directly to the binary inputs. One input is available for "slow speed" (up to about 300 Hz) and one for "high speed" (up to about 10 kHz). The current flow rate, partial quantity and total quantity can be displayed in different units (l/s, l/min, l/h, m³/min, m³/h, GAL(US)/s, GAL(US)/min, GAL(US)/h, or l, m³, GAL(US)).

Data logger

Up to 43,500 data sets can be stored in the data logger (ring buffer). Depending on the resolution, that corresponds to a storage time ranging from about 10 hours to 150 days. Data can be read by means of the setup program and then further processed with an "Office" product. The data logger makes it possible to record and document processes and supports analysis of the same processes.

Contact functions

Max. limit function

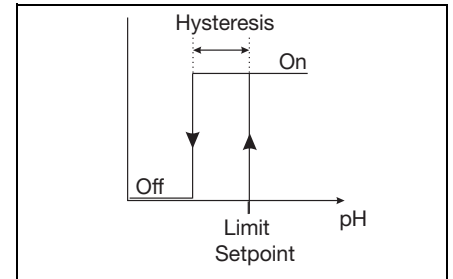

Min. limit function

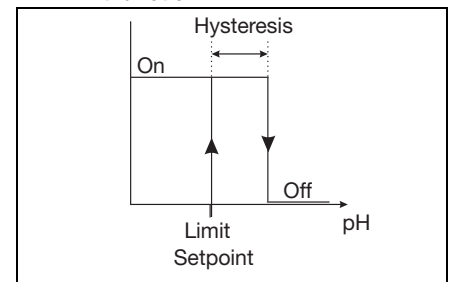

Alarm window 1

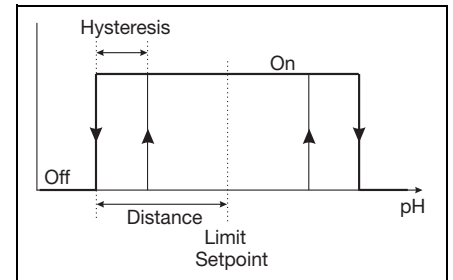

Alarm window 2

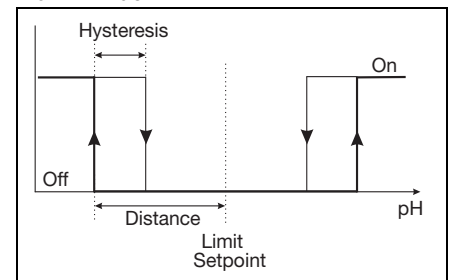

Pulse contact

Triggering condition longer than pulse duration

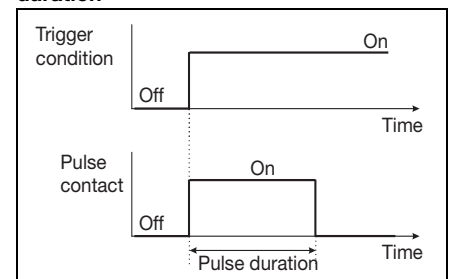



Pulse contact

Triggering condition shorter than pulse duration

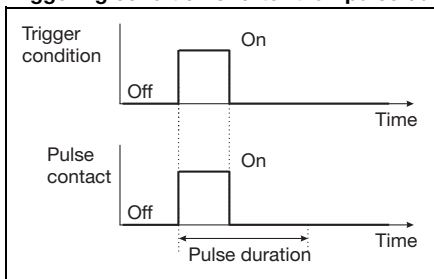

Pulse width controller

(output active with $x > w$ and P control structure)

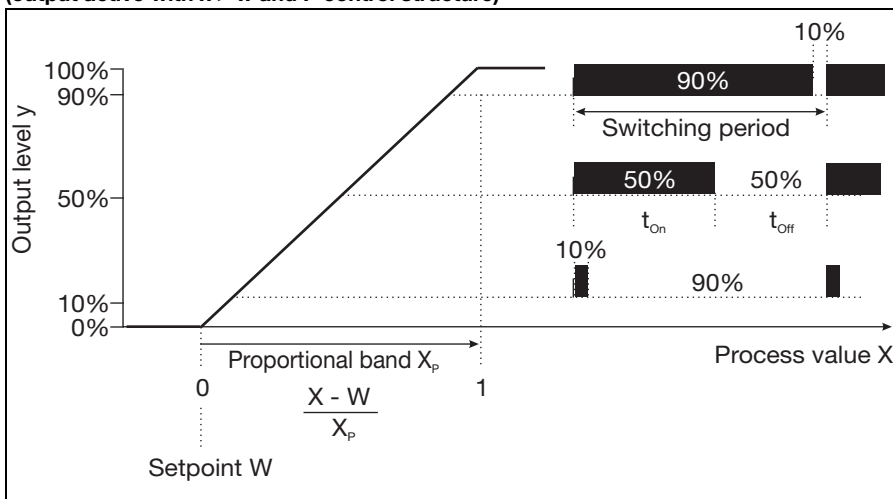

If actual value x exceeds setpoint w , the P controller will control in proportion to the control deviation. When the proportional band is exceeded, the controller operates with an output level of 100 % (100 % clock ratio).

Pulse frequency controller

(output active with $x > w$ and P control structure)

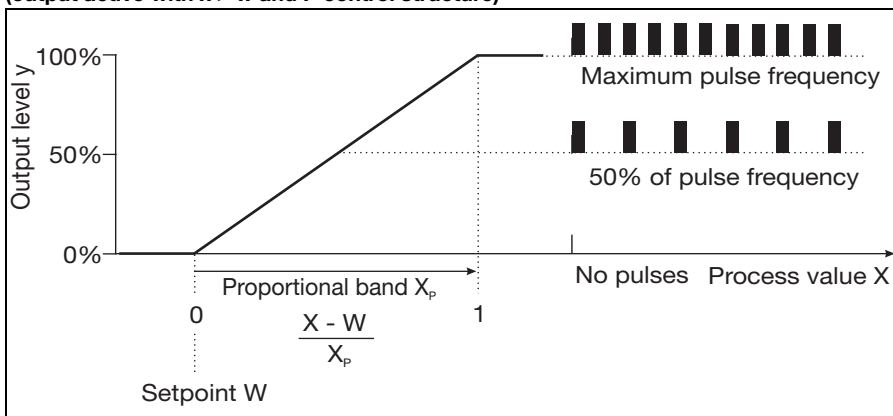

If actual value x exceeds setpoint w , the P controller will control in proportion to the control deviation. When the proportional band is exceeded, the controller operates with an output level of 100 % (maximum switching frequency).

Math and logic module

The math module makes it possible to integrate measurement value of the analog inputs into a mathematical formula so that the calculated process variable can be displayed. The logic module can be used, for example, to link binary inputs and limit comparators with each other logically.

Up to two math or logic formulas can be entered with the setup program and the results of calculations can be displayed or exported via outputs (via PC setup software only).

Setup PC program (accessory)

The setup PC program is available in German, English and French for configuring the instrument. You can use it to create and edit sets of data and transfer them to the instrument, as well as read them out from it. The data can be stored and printed.

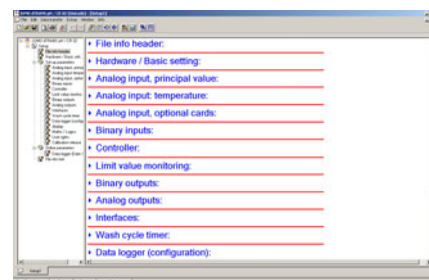

Setup interface

The setup interface is integrated into the JUMO dTRANS pH 02 by default. You can use it, together with the setup program (accessory) and a setup interface (accessory), to configure the instrument.

RS232/RS485 interface

The serial interface is used for communication with higher-level systems when the Modbus/Jbus protocol is used.

PROFIBUS-DP

The JUMO dTRANS pH 02 can be integrated into a fieldbus system according to the PROFIBUS-DP standard via the PROFIBUS-DP interface. This PROFIBUS-DP version is especially designed for communication between automation systems and distributed peripheral devices at the field level and is optimized for speed.

Data is transferred serially based on the RS485 standard.

Using the project design tool that is included in the delivery (GSD generator; GSD = device master file), a standardized GSD file is created by selecting characteristic device features of the JUMO dTRANS pH 02. This file is used to integrate the controller into the fieldbus system.

JUMO GmbH & Co. KG
 Delivery address: Mackenrodtstraße 14
 36039 Fulda, Germany
 Postal address: 36035 Fulda, Germany
 Phone: +49 661 6003-0
 Fax: +49 661 6003-607
 Email: mail@jumo.net
 Internet: www.jumo.net

JUMO Instrument Co. Ltd.
 JUMO House
 Temple Bank, Riverway
 Harlow, Essex CM 20 2DY, UK
 Phone: +44 1279 63 55 33
 Fax: +44 1279 62 50 29
 Email: sales@jumo.co.uk
 Internet: www.jumo.co.uk

JUMO Process Control, Inc.
 6733 Myers Road
 East Syracuse, NY 13057, USA
 Phone: +1 315 437 5866
 Fax: +1 315 437 5860
 Email: info.us@jumo.net
 Internet: www.jumousa.com



Technical data

Inputs (main board)

Main input	Measuring range/control range	Accuracy	Effect of temperature
pH value	-2 to +16 pH	≤ 0.3 % of range	0.2 %/10 K
Redox potential	-1500 to +1500 mV	≤ 0.3 % of range	0.2 %/10 K
NH ₃ (ammonia)	0 to 9999 ppm	≤ 0.3 % of range	0.2 %/10 K
Secondary input			
Temperature Pt100/1000	-50 to +250 °C ^a	≤ 0.25 % of range	0.2 %/10 K
Temperature NTC/PTC	0.1 to 30 kΩ Entry via table with 20 value pairs	≤ 1.5 % of range	0.2 %/10 K
Standard signal	0(4) to 20 mA or 0 to 10 V	0.25 % of range	0.2 %/10 K
Resistance transmitter	Minimum: 100 Ω Maximum: 3 kΩ	±5 Ω	0.1 %/10 K

^a Selectable in °F.

Resistance thermometer inputs (optional board)

Designation	Connection type	Measuring range	Measuring accuracy		Effect of ambient temperature
			3-wire/4-wire	2-wire	
Pt100 DIN EN 60751 (factory-set)	2-wire/3-wire 4-wire	-200 to +850 °C	≤ 0.05 %	≤ 0.4 %	50 ppm/°C
Pt1000 DIN EN 60751 (factory-set)	2-wire/3-wire 4-wire	-200 to +850 °C	≤ 0.1 %	≤ 0.2 %	50 ppm/°C
Sensor lead resistance	Maximum 30 Ω per line with three- and four-wire circuit				
Measurement current	approx. 250 µA				
Lead compensation	Not required for three- and four-wire circuit. With a 2-wire circuit, lead resistance can be compensated in the software by correcting the process value.				

Standard signals inputs (optional board)

Designation	Measuring range	Measuring accuracy	Effect of ambient temperature
Voltage	0(2) to 10 V 0 to 1 V Input resistance _E > 100 kΩ	≤ 0.05 %	100 ppm/°C
Electrical current	0(4) to 20 mA, Voltage drop ≤ 1.5 V	≤ 0.05 %	100 ppm/°C
Resistance transmitter	Minimum: 100 Ω Maximum: 4 kΩ	±4 Ω	100 ppm/°C

Temperature compensation

Measurement variable	Compensation	Range ^a
pH value	Yes	-10 to +150°C
Redox potential	No	Not applicable
NH ₃ (ammonia)	Yes	-20 to +50°C

^a Note the sensor operating temperature range!

JUMO GmbH & Co. KG
 Delivery address: Mackenrodtstraße 14
 36039 Fulda, Germany
 Postal address: 36035 Fulda, Germany
 Phone: +49 661 6003-0
 Fax: +49 661 6003-607
 Email: mail@jumo.net
 Internet: www.jumo.net

JUMO Instrument Co. Ltd.
 JUMO House
 Temple Bank, Riverway
 Harlow, Essex CM 20 2DY, UK
 Phone: +44 1279 63 55 33
 Fax: +44 1279 62 50 29
 Email: sales@jumo.co.uk
 Internet: www.jumo.co.uk

JUMO Process Control, Inc.
 6733 Myers Road
 East Syracuse, NY 13057, USA
 Phone: +1 315 437 5866
 Fax: +1 315 437 5860
 Email: info.us@jumo.net
 Internet: www.jumousa.com



Measuring circuit monitoring

Inputs	Over range/underrange	Short circuit	Broken lead
pH value	Yes	Yes ^a	Yes ^a
Redox potential	Yes	No	No
NH ₃ (ammonia)	Yes	No	No
Temperature	Yes	Yes	Yes
Voltage	2 to 10 V	Yes	Yes
	0 to 10 V	Yes	No
Current	4 to 20 mA	Yes	Yes
	0 to 20 mA	Yes	No
Resistance transmitter	No	No	Yes

^a The sensor can be monitored for short circuit and broken lead during the pH measurement by activating the impedance measurement.

Impedance measurement

The impedance measurement can optionally be activated. Because it depends on some boundary parameters, note the following points:

- Only glass-based sensors are permitted.
- The sensors must be connected directly to the transmitter. Only one impedance converter may be used in the measuring circuit!
- The maximum permissible line length between sensor and transmitter is 10 m.
- Liquid resistances are included directly in the measurement results.

We therefore recommend activating the measurement in liquids beginning with a minimum conductivity of about 100 µS/cm.

Binary input

Activation	Floating contact is open: function is not active Floating contact is closed: function is active
Function	Key lock, manual mode, HOLD, HOLD inverse, alarm suppression, freeze measured value, level lock, reset day counter, reset total counter, parameter set changeover, flow-rate measurement
Pulse input for flow measurement	Binary input 1: approx. 3 to 2000 Hz, resolution 2 Hz Binary input 2: approx. 4 to 300 Hz, resolution 0,5 Hz At the device only one binary input for flow measurement can be used.

Controller

Controller type	Limit comparators, limit controllers, pulse length controllers, pulse frequency controllers, modulating controllers, continuous controllers
Controller structure	P/PI/PD/PID

Outputs

Relay (changeover)	PSU board	5 A at AC 240 V resistive load 350,000 operations at nominal load/750,000 operations at 1 A
Contact rating		
Contact service life		
Voltage supply for 2-wire transmitter	PSU board	Electrically isolated, non-controlled DC 17 V at 20 mA, open-circuit voltage approx. DC 25 V
Voltage supply for ISFET	Optional board	DC ±5 V; 5 mA
Voltage supply for inductive proximity switch	Optional board	DC 12 V; 10 mA
Relay (changeover)	Optional board	8 A at AC 240 V resistive load 100,000 operations at nominal load/350,000 operations at 3 A
Contact rating		
Contact service life		
Relay SPST (normally open)	Optional board	
Contact rating		3 A at AC 240 V resistive load
Contact service life		350,000 operations at nominal load/900,000 operations at 1 A
Semiconductor relay	Optional board	
Contact rating		1 A at 240 V
Protective circuit		Varistor

JUMO GmbH & Co. KG
 Delivery address: Mackenrodtstraße 14
 36039 Fulda, Germany
 Postal address: 36035 Fulda, Germany
 Phone: +49 661 6003-0
 Fax: +49 661 6003-607
 Email: mail@jumo.net
 Internet: www.jumo.net

JUMO Instrument Co. Ltd.
 JUMO House
 Temple Bank, Riverway
 Harlow, Essex CM 20 2DY, UK
 Phone: +44 1279 63 55 33
 Fax: +44 1279 62 50 29
 Email: sales@jumo.co.uk
 Internet: www.jumo.co.uk

JUMO Process Control, Inc.
 6733 Myers Road
 East Syracuse, NY 13057, USA
 Phone: +1 315 437 5866
 Fax: +1 315 437 5860
 Email: info.us@jumo.net
 Internet: www.jumousa.com



PhotoMOS® relay	Optional board	U ≤ DC 45 V U ≤ AC 30 V I ≤ 200 mA
Voltage Output signals Load resistance Accuracy	Optional board	0 to 10 V or 2 to 10 V R _{load} ≥ 500 Ω ≤ 0.5 %
Electrical current Output signals Load resistance Accuracy	Optional board	0 to 20 mA or 4 to 20 mA R _{load} ≤ 500 Ω ≤ 0.5 %

Display

Type	LC graphic display, blue with background lighting, 122 × 32 pixels
------	--

Electrical data

Voltage supply (switch-mode PSU)	AC 110 to 240 V +10/-15 %; 48 to 63 Hz or AC/DC 20 to 30 V; 48 to 63 Hz
Electrical safety	To DIN EN 61010, Part 1 overvoltage category II, pollution degree 2
Power draw	Approx. 14 VA (20 A fuse max.)
Data backup	EEPROM
Electrical connection	On the back via screw terminals, conductor cross-section up to max. 2.5 mm ²
Electromagnetic Compatibility (EMC) Interference emission Interference immunity	DIN EN 61326-1 Class A To industrial requirements

Case

Enclosure type	Plastic case for panel mounting to DIN IEC 61554 (indoor use)
Depth behind panel	90 mm
Ambient temperature Storage temperature	-5 to +55 °C -30 to +70 °C
Climatic rating	Rel. humidity ≤ 90 % annual mean, no condensation
Site altitude	Up to 2000 m above sea level
Operating position	Horizontal
Enclosure protection In panel case In surface-mounted case	To DIN EN 60529 Front IP65, rear IP20 IP65
Weight (fully fitted)	About 380 g

Interface

Modbus	
Interface type	RS422/RS485
Protocol	Modbus, Modbus Integer
Baud rate	9600, 19200, 38400
Device address	0 to 255
Max. number of nodes	32
PROFIBUS-DP	
Device address	0 to 255

Approvals/marks of conformity

Mark of conformity	Testing laboratory	Certificates/certification numbers	Test basis	valid for
c UL us	Underwriters Laboratories	E 201387	UL 61010-1 CAN/CSA-C22.2 No. 61010-1	Type 202551/01...

JUMO GmbH & Co. KG
 Delivery address: Mackenrodtstraße 14
 36039 Fulda, Germany
 Postal address: 36035 Fulda, Germany
 Phone: +49 661 6003-0
 Fax: +49 661 6003-607
 Email: mail@jumo.net
 Internet: www.jumo.net

JUMO Instrument Co. Ltd.
 JUMO House
 Temple Bank, Riverway
 Harlow, Essex CM 20 2DY, UK
 Phone: +44 1279 63 55 33
 Fax: +44 1279 62 50 29
 Email: sales@jumo.co.uk
 Internet: www.jumo.co.uk

JUMO Process Control, Inc.
 6733 Myers Road
 East Syracuse, NY 13057, USA
 Phone: +1 315 437 5866
 Fax: +1 315 437 5860
 Email: info.us@jumo.net
 Internet: www.jumousa.com



Electrical connection

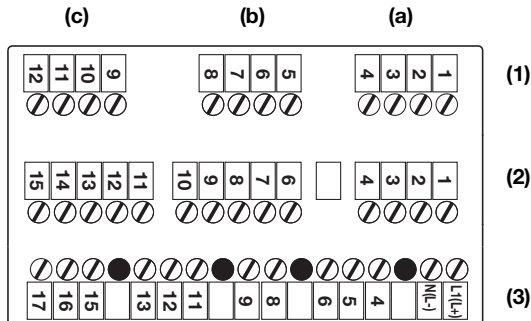

Mounting information for conductor cross-sections and ferrules

Ferrule	Conductor cross-section		Minimum ferrule length or stripping
	Minimum	Maximum	
Without ferrule	0.34 mm ²	2.5 mm ²	10 mm (stripping)
Without collar	0.25 mm ²	2.5 mm ²	10 mm
With collar up to 1.5mm ²	0.25 mm ²	1.5 mm ²	10 mm
Twin, with collar	0.25 mm ²	1.5 mm ²	12 mm

(1)	Row 1	(a)	Option 1	(b)	Option 2	(c)	Option 3
(2)	Row 2	Main board (pH/redox/temperature/standard signal)					
(3)	Row 3	PSU board (voltage supply/2x relays)					

Optional board (row 1, slot a, b or c)

Function	Symbol	Terminal for slot (a)	Terminal for slot (b)	Terminal for slot (c)
Analog input				
Temperature sensor in a two-wire circuit Pt100 or Pt1000		2 4	6 8	10 12
Temperature sensor in a three-wire circuit Pt100 or Pt1000		2 3 4	6 7 8	10 11 12
Resistance transmitter		2 3 4	6 7 8	10 11 12
Electrical current		3 4	7 8	11 12
Voltage 0(2) to 10 V		1 2	5 6	9 10
Voltage 0 to 1 V		2 3	6 7	10 11
Continuous output				
Current or voltage		2 3	6 7	10 11
Modbus interface				
RS422		-	-	9 10 11 12
RS485		-	-	11 12

JUMO GmbH & Co. KG
 Delivery address: Mackenrodtstraße 14
 36039 Fulda, Germany
 Postal address: 36035 Fulda, Germany
 Phone: +49 661 6003-0
 Fax: +49 661 6003-607
 Email: mail@jumo.net
 Internet: www.jumo.net

JUMO Instrument Co. Ltd.
 JUMO House
 Temple Bank, Riverway
 Harlow, Essex CM 20 2DY, UK
 Phone: +44 1279 63 55 33
 Fax: +44 1279 62 50 29
 Email: sales@jumo.co.uk
 Internet: www.jumo.co.uk

JUMO Process Control, Inc.
 6733 Myers Road
 East Syracuse, NY 13057, USA
 Phone: +1 315 437 5866
 Fax: +1 315 437 5860
 Email: info.us@jumo.net
 Internet: www.jumousa.com



Function	Symbol	Terminal for slot (a)	Terminal for slot (b)	Terminal for slot (c)
PROFIBUS-DP interface				
		-	-	9 10 11 12
Data logger interface				
RS485		-	-	10 11
Relay (1x changeover)				
		K3 1 2 3	K4 5 6 7	K5 9 10 11
Relay (2x NO, common pin)				
		K3 1 2 K6 3	-	K5 9 10 K8 11
Triac (1 A)				
		K3 2 3	K4 6 7	K5 10 11
PhotoMOS[®] relay (0.2 A)				
		K3 1 2	K4 5 6	K5 9 10
		K6 3 4	K7 7 8	K8 11 12
Voltage supply for ISFET sensor				
DC ±5 V GND		1 2 3 4	5 6 7 8	9 10 11 12
DC +12 V GND		1 2	5 6	9 10

JUMO GmbH & Co. KG
 Delivery address: Mackenrodtstraße 14
 36039 Fulda, Germany
 Postal address: 36035 Fulda, Germany
 Phone: +49 661 6003-0
 Fax: +49 661 6003-607
 Email: mail@jumo.net
 Internet: www.jumo.net

JUMO Instrument Co. Ltd.
 JUMO House
 Temple Bank, Riverway
 Harlow, Essex CM 20 2DY, UK
 Phone: +44 1279 63 55 33
 Fax: +44 1279 62 50 29
 Email: sales@jumo.co.uk
 Internet: www.jumo.co.uk

JUMO Process Control, Inc.
 6733 Myers Road
 East Syracuse, NY 13057, USA
 Phone: +1 315 437 5866
 Fax: +1 315 437 5860
 Email: info.us@jumo.net
 Internet: www.jumousa.com



Main board (row 2)

Function	Symbol	Terminal
Voltage supply for ISFET sensor DC ± 4.85 V GND		11 10 15
Standard signal input for electrical current 0(4) to 20 mA		3 4
Standard signal input for voltage 0(2) to 10 V or 10 to 0(2) V		1 4
Temperature sensor in a two-wire circuit Pt100 or Pt1000		2 3 4
Temperature sensor in a three-wire circuit Pt100 or Pt1000		2 3 4
Resistance transmitter		4 3 2
pH/redox electrode		
Shield for pH (with triaxial cable only!)		6
Glass/metal electrode		7
Reference electrode		8
Liquid potential (LP) With asymmetrical connection, bridge between terminal 8 and 9 With symmetrical connection, LP on terminal 9		9
Binary inputs^a		
Binary input 1 3 to 2000 Hz, resolution 2 Hz		12+ 14
Binary input 2 4 to 300 Hz, resolution 0,5 Hz		13+ 14

^a The binary inputs can be used as counter inputs for flow measurement with flow sensors (see application example on page 16).

JUMO GmbH & Co. KG
 Delivery address: Mackenrodtstraße 14
 36039 Fulda, Germany
 Postal address: 36035 Fulda, Germany
 Phone: +49 661 6003-0
 Fax: +49 661 6003-607
 Email: mail@jumo.net
 Internet: www.jumo.net

JUMO Instrument Co. Ltd.
 JUMO House
 Temple Bank, Riverway
 Harlow, Essex CM 20 2DY, UK
 Phone: +44 1279 63 55 33
 Fax: +44 1279 62 50 29
 Email: sales@jumo.co.uk
 Internet: www.jumo.co.uk

JUMO Process Control, Inc.
 6733 Myers Road
 East Syracuse, NY 13057, USA
 Phone: +1 315 437 5866
 Fax: +1 315 437 5860
 Email: info.us@jumo.net
 Internet: www.jumousa.com



PSU board (row 3)

Function	Symbol	Terminal
Voltage supply for JUMO dTRANS 02		
Voltage supply: AC 110 to 240 V		1 L1 (L+)
Voltage supply: AC/DC 20 to 30 V		2 N (L-)
n.c.		4 5 6
Voltage supply for external 2-wire transmitter		
DC 24 V (+20/-15 %)		8 L +
		9 L -
Relay 1		
Switching output K1 (floating)		11 12 13
Relay 2		
Switching output K2 (floating)		15 16 17

JUMO GmbH & Co. KG
 Delivery address: Mackenrodtstraße 14
 36039 Fulda, Germany
 Postal address: 36035 Fulda, Germany
 Phone: +49 661 6003-0
 Fax: +49 661 6003-607
 Email: mail@jumo.net
 Internet: www.jumo.net

JUMO Instrument Co. Ltd.
 JUMO House
 Temple Bank, Riverway
 Harlow, Essex CM 20 2DY, UK
 Phone: +44 1279 63 55 33
 Fax: +44 1279 62 50 29
 Email: sales@jumo.co.uk
 Internet: www.jumo.co.uk

JUMO Process Control, Inc.
 6733 Myers Road
 East Syracuse, NY 13057, USA
 Phone: +1 315 437 5866
 Fax: +1 315 437 5860
 Email: info.us@jumo.net
 Internet: www.jumousa.com



Dimensions

Panel case

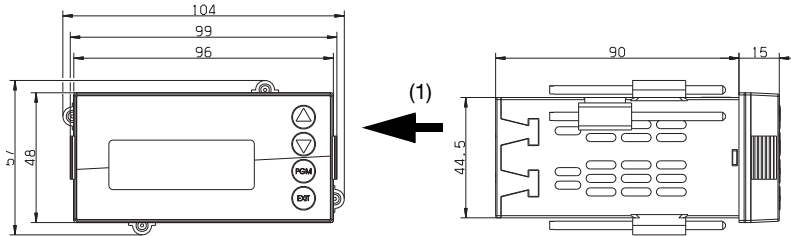

Close mounting

Minimum spacing of panel cutouts	Horizontal	Vertical
Without setup connector	30 mm	11 mm
With setup connector (see arrow)	65 mm	11 mm

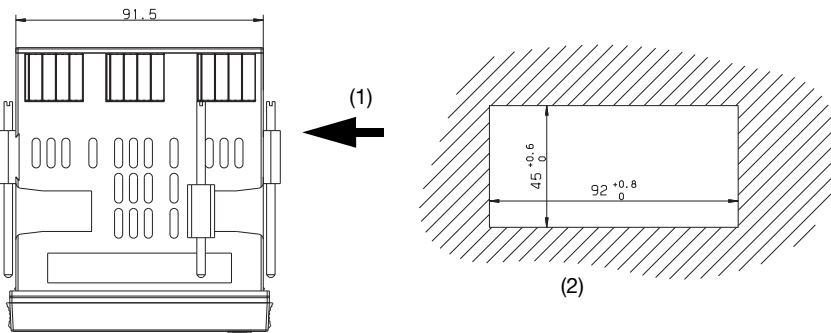

- (1) PC interface socket
- (2) Panel cutout to DIN IEC 61554: 2002-08

Surface-mounted case

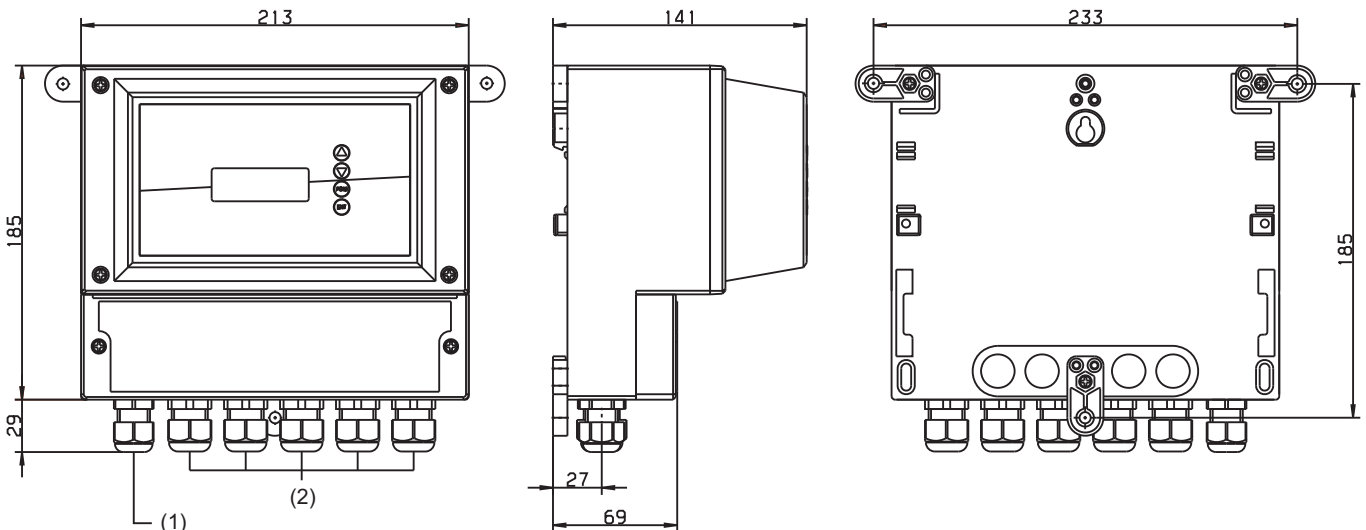

- (1) Cable gland M16
- (2) Cable gland M20

JUMO GmbH & Co. KG
 Delivery address: Mackenrodtstraße 14
 36039 Fulda, Germany
 Postal address: 36035 Fulda, Germany
 Phone: +49 661 6003-0
 Fax: +49 661 6003-607
 Email: mail@jumo.net
 Internet: www.jumo.net

JUMO Instrument Co. Ltd.
 JUMO House
 Temple Bank, Riverway
 Harlow, Essex CM 20 2DY, UK
 Phone: +44 1279 63 55 33
 Fax: +44 1279 62 50 29
 Email: sales@jumo.co.uk
 Internet: www.jumo.co.uk

JUMO Process Control, Inc.
 6733 Myers Road
 East Syracuse, NY 13057, USA
 Phone: +1 315 437 5866
 Fax: +1 315 437 5860
 Email: info.us@jumo.net
 Internet: www.jumousa.com



Application examples

pH measurement (temperature compensated)

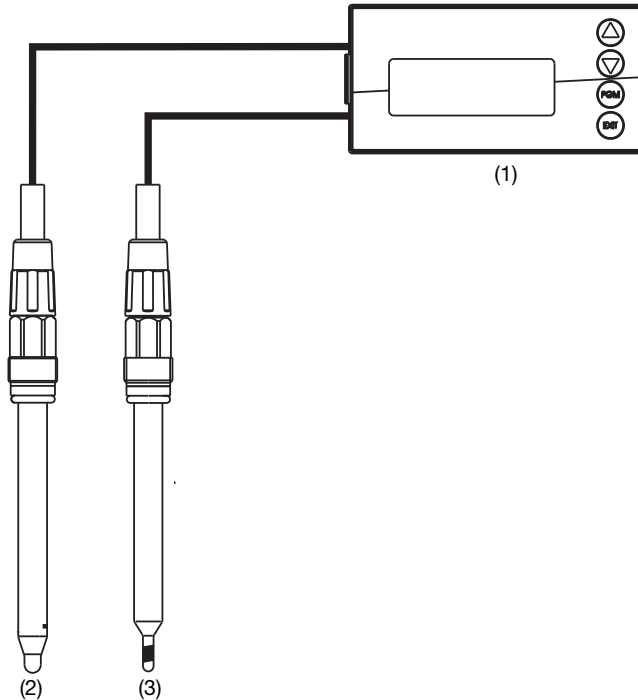

- (1) JUMO dTRANS pH 02
- (2) pH combination electrode
- (3) Compensation thermometer, type 201085

Redundant pH measurement (temperature compensated)

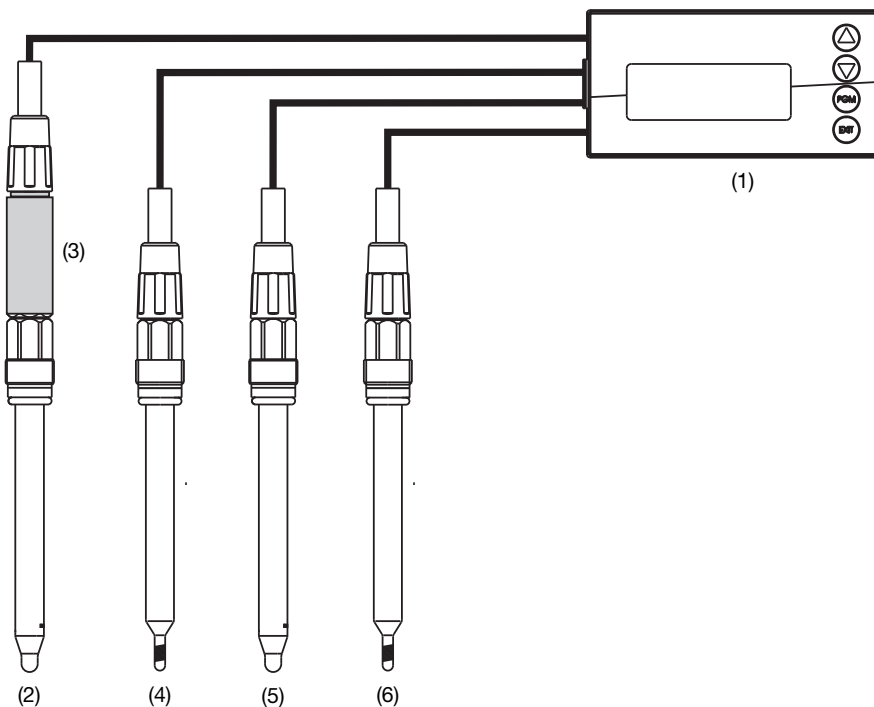

- (1) JUMO dTRANS pH 02
- (2) pH combination electrode
- (3) JUMO digiLine pH with analog output, type 202705
- (4) Compensation thermometer, type 201085
- (5) pH combination electrode
- (6) Compensation thermometer, type 201085

JUMO GmbH & Co. KG
 Delivery address: Mackenrodtstraße 14
 36039 Fulda, Germany
 Postal address: 36035 Fulda, Germany
 Phone: +49 661 6003-0
 Fax: +49 661 6003-607
 Email: mail@jumo.net
 Internet: www.jumo.net

JUMO Instrument Co. Ltd.
 JUMO House
 Temple Bank, Riverway
 Harlow, Essex CM 20 2DY, UK
 Phone: +44 1279 63 55 33
 Fax: +44 1279 62 50 29
 Email: sales@jumo.co.uk
 Internet: www.jumo.co.uk

JUMO Process Control, Inc.
 6733 Myers Road
 East Syracuse, NY 13057, USA
 Phone: +1 315 437 5866
 Fax: +1 315 437 5860
 Email: info.us@jumo.net
 Internet: www.jumousa.com



pH-compensated chlorine measurement (pH measurement temperature compensated)

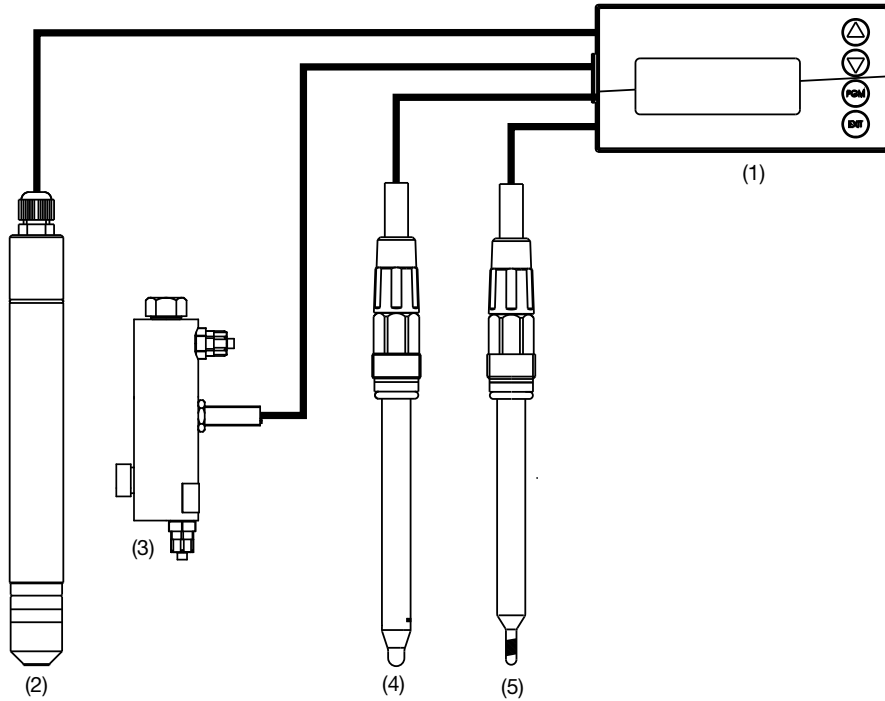

- (1) JUMO dTRANS pH 02
- (2) Measuring cell for free chlorine, type 202630
- (3) Flow monitor, type 202811/20
- (4) pH combination electrode
- (5) Compensation thermometer, type 201085

Redox measurement and pH measurement (temperature compensated)

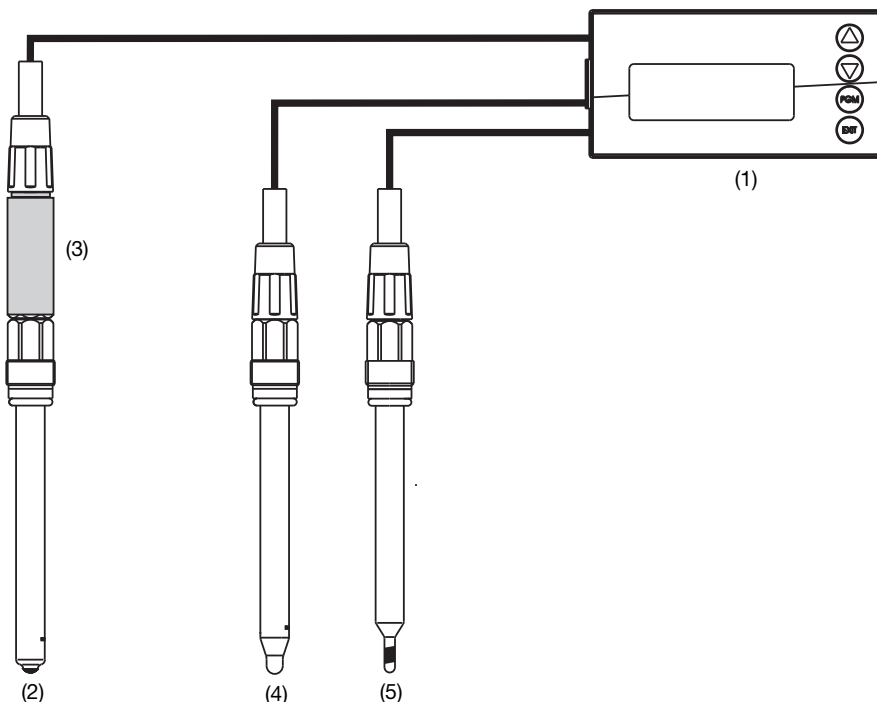

- (1) JUMO dTRANS pH 02
- (2) Redox combination electrode
- (3) JUMO digiLine pH with analog output, type 202705
- (4) pH combination electrode
- (5) Compensation thermometer, type 201085

JUMO GmbH & Co. KG
 Delivery address: Mackenrodtstraße 14
 36039 Fulda, Germany
 Postal address: 36035 Fulda, Germany
 Phone: +49 661 6003-0
 Fax: +49 661 6003-607
 Email: mail@jumo.net
 Internet: www.jumo.net

JUMO Instrument Co. Ltd.
 JUMO House
 Temple Bank, Riverway
 Harlow, Essex CM 20 2DY, UK
 Phone: +44 1279 63 55 33
 Fax: +44 1279 62 50 29
 Email: sales@jumo.co.uk
 Internet: www.jumo.co.uk

JUMO Process Control, Inc.
 6733 Myers Road
 East Syracuse, NY 13057, USA
 Phone: +1 315 437 5866
 Fax: +1 315 437 5860
 Email: info.us@jumo.net
 Internet: www.jumousa.com



pH value (temperature compensated) and flow-rate measurement

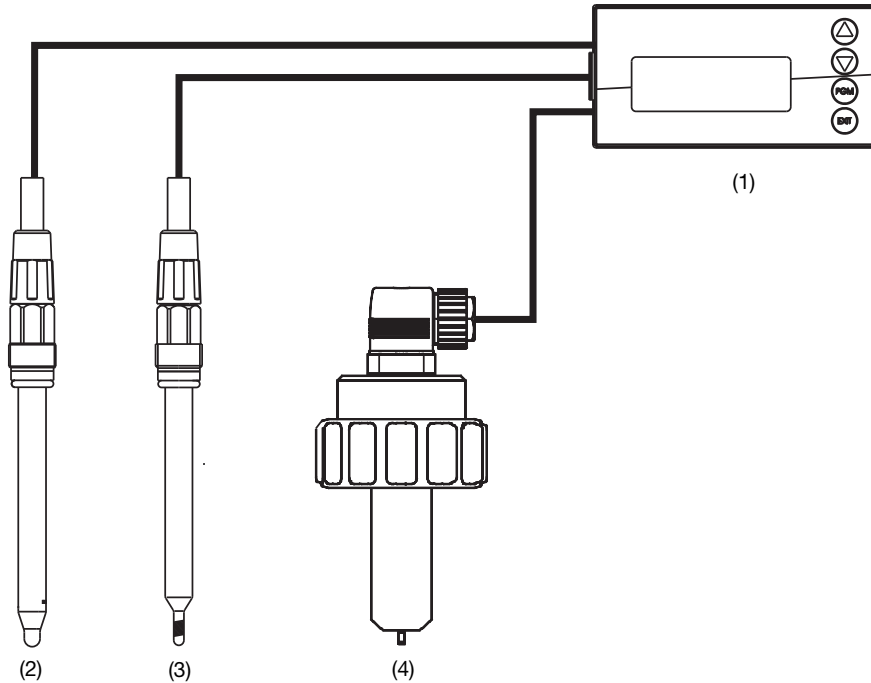

- (1) JUMO dTRANS pH 02
- (2) pH combination electrode
- (3) Compensation thermometer, type 201085
- (4) Flow sensor, type 406010 (magnetic-inductive) or type 406020 (padle wheel)

pH value (temperature compensated) and level or liquid level measurement¹

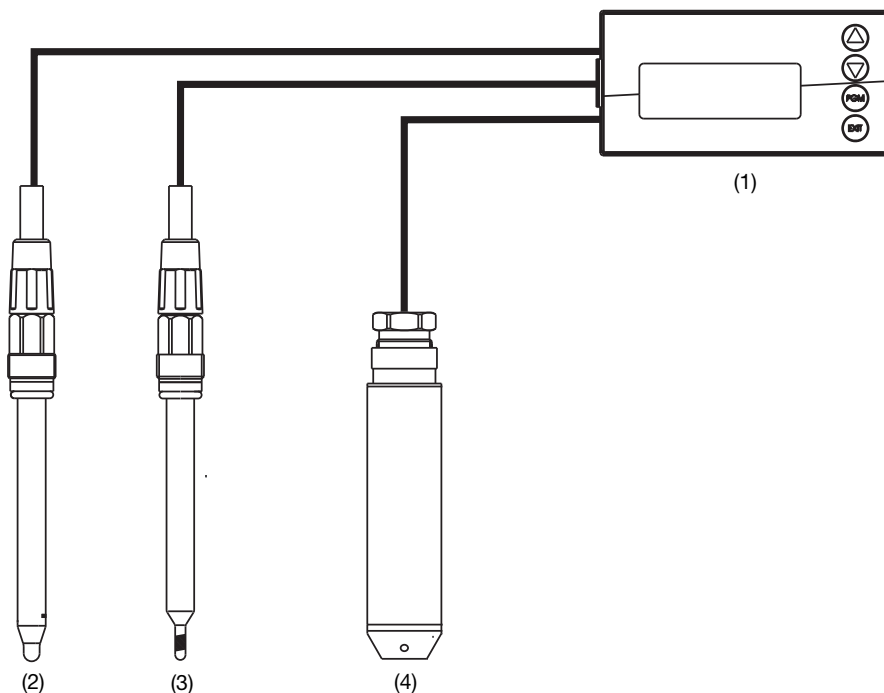

- (1) JUMO dTRANS pH 02
- (2) pH combination electrode
- (3) Compensation thermometer, type 201085
- (4) Level measurement probe Type JUMO dTRANS p90 or type 402090 or type 404391

¹ The setup program, which is available as an option, can be used to linearly assign a display in liters or other unit to a non-linear input variable such as the volume of a horizontal, cylindrical tank (20 value pairs).

JUMO GmbH & Co. KG
 Delivery address: Mackenrodtstraße 14
 36039 Fulda, Germany
 Postal address: 36035 Fulda, Germany
 Phone: +49 661 6003-0
 Fax: +49 661 6003-607
 Email: mail@jumo.net
 Internet: www.jumo.net

JUMO Instrument Co. Ltd.
 JUMO House
 Temple Bank, Riverway
 Harlow, Essex CM 20 2DY, UK
 Phone: +44 1279 63 55 33
 Fax: +44 1279 62 50 29
 Email: sales@jumo.co.uk
 Internet: www.jumo.co.uk

JUMO Process Control, Inc.
 6733 Myers Road
 East Syracuse, NY 13057, USA
 Phone: +1 315 437 5866
 Fax: +1 315 437 5860
 Email: info.us@jumo.net
 Internet: www.jumousa.com



Order details

(1) Basic type	
202551/01	JUMO dTRANS pH 02 - Transmitter/controller for pH, redox, ammonia, standard signals and temperature in panel case, 96 mm x 48 mm (front IP65)
202551/05	JUMO dTRANS pH 02 - Transmitter/controller for pH, redox, ammonia, standard signals and temperature in surface-mounted case (IP67)
(2) Version	
8	Standard with factory setting
9	Programming to customer specification
(3) Operating language^a	
01	German
02	English
03	French
04	Dutch
05	Russian
06	Italian
07	Hungarian
08	Czech
09	Swedish
10	Polish
13	Portuguese
14	Spanish
16	Rumanian
(4) Optional slot 1	
0	Not used
1	Analog input (universal)
2	Relay (1x changeover)
3	Relay (2x normally open)
4	Analog output
5	2 PhotoMOS [®] relays
6	Solid state relay 1 A
7	Voltage supply output ±5 V DC (e.g. for ISFET)
8	Voltage supply output 12 V DC (e.g. for inductive proximity switch)
(5) Optional slot 2	
0	Not used
1	Analog input (universal)
2	Relay (1x changeover)
4	Analog output
5	2 PhotoMOS [®] relays
6	Solid state relay 1 A
7	Voltage supply output ±5 V DC (e.g. for ISFET)
8	Voltage supply output 12 V DC (e.g. for inductive proximity switch)
(6) Optional slot 3	
0	Not used
1	Analog input (universal)
2	Relay (1x changeover)
3	Relay (2x normally open)
4	Analog output
5	2 PhotoMOS [®] relays
6	Solid state relay 1 A
7	Voltage supply output ±5 V DC (e.g. for ISFET)
8	Voltage supply output 12 V DC (e.g. for inductive proximity switch)

JUMO GmbH & Co. KG
 Delivery address: Mackenrodtstraße 14
 36039 Fulda, Germany
 Postal address: 36035 Fulda, Germany
 Phone: +49 661 6003-0
 Fax: +49 661 6003-607
 Email: mail@jumo.net
 Internet: www.jumo.net

JUMO Instrument Co. Ltd.
 JUMO House
 Temple Bank, Riverway
 Harlow, Essex CM 20 2DY, UK
 Phone: +44 1279 63 55 33
 Fax: +44 1279 62 50 29
 Email: sales@jumo.co.uk
 Internet: www.jumo.co.uk

JUMO Process Control, Inc.
 6733 Myers Road
 East Syracuse, NY 13057, USA
 Phone: +1 315 437 5866
 Fax: +1 315 437 5860
 Email: info.us@jumo.net
 Internet: www.jumousa.com



10	Interface RS422/485
11	Data logger with interface RS485 ^b
12	PROFIBUS-DP interface
(7) Voltage supply	
23	AC 110 to 230 V, +10/-15 %, 48 to 63 Hz
25	AC/DC 20 to 30 V, 48 to 63 Hz
(8) Extra code	
000	None

^a All languages are available on the instrument and can be changed by the customer at any time. Factory default setting to a language (other than "German") is available for a charge.

^b The only way to read data is with the PC setup software!

Order code (1) (2) (3) (4) (5) (6) (7) (8) , ...^a
 [] - [] - [] - [] - [] - [] - [] / []
Order example 202551/01 - 8 - 01 - 2 - 2 - 4 - 23 / 000

^a List extra codes in sequence, separated by commas.

Stock versions

(delivery 3 working days after receipt of order)

Order code	Part no.
202551/01-8-01-4-0-2-23/000	00560378
202551/01-8-01-4-0-0-23/000	00560379
202551/01-8-01-4-0-0-25/000	00568079

Accessories

(delivery 10 working days after receipt of order)

Item	Part no.
Holder for C rail (PG 709710)	00375749
Dummy cover 96 mm x 48 mm (PG 709710)	00069680
Pipe mounting set (PG 209791)	00398162
Weather protection roof complete for basic type extension 05 (PG 209791)	00401174
PC setup software (PG 202599)	00560380
PC interface cable including USB/TTL converter and two adapters (USB connecting cable) (PG 709720)	00456352

Optional board	Code	Sales No.
Analog input (universal)	1	00442785
Relay (1x changeover)	2	00442786
Relay (2x NO)	3	00442787
Analog output	4	00442788
2 PhotoMOS [®] relays	5	00566677
Solid state relay 1 A	6	00442790
Voltage supply output DC ±5 V (e.g. for ISFET)	7	00566681
Voltage supply output DC 12 V (e.g. for inductive proximity switch)	8	00566682
Interface RS422/485	10	00442782
Data logger with RS485 interface	11	00566678
PROFIBUS-DP interface	12	00566679