

**JUMO GmbH & Co. KG**  
 Delivery address: Mackenrodtstraße 14,  
 36039 Fulda, Germany  
 Postal address: 36035 Fulda, Germany  
 Phone: +49 661 6003-0  
 Fax: +49 661 6003-607  
 e-mail: mail@jumo.net  
 Internet: www.jumo.net

**JUMO Instrument Co. Ltd.**  
 JUMO House  
 Temple Bank, Riverway  
 Harlow, Essex CM 20 2TT, UK  
 Phone: +44 1279 635533  
 Fax: +44 1279 635262  
 e-mail: sales@jumo.co.uk  
 Internet: www.jumo.co.uk

**JUMO Process Control, Inc.**  
 8 Technology Boulevard  
 Canastota, NY 13032, USA  
 Phone: 315-697-JUMO  
 1-800-554-JUMO  
 Fax: 315-697-5867  
 e-mail: info@jumo.us  
 Internet: www.jumo.us



# JUMO dTRANS Az 01 µP Indicator/Controller for analytical measurement

## Type 202550 Panel-mounting housing to DIN 43 700

### Brief description

The instrument with 96mm x 48mm bezel and plug-in controller module visualizes and controls variables in analytical measurement (pH value, redox voltage, conductivity, high-purity water, oxygen, free chlorine, chlorine dioxide, ozone etc.).

The indicator has two analog and two logic inputs. The first analog input is suitable for connecting a 0(4) – 20 mA signal, which can be provided by any type of transmitter (including 2-wire types). The input signal is conditioned, as determined by the configuration, and displayed. One special feature of the instrument is that the calibration procedures for pH, redox and conductivity are internally programmed. The second analog input can be used to connect Pt100 or Pt1000 resistance thermometers.

The instrument features two 4-digit 7-segment displays for indicating the main variable (red) and the temperature (green). The temperature display is switched off in the default setting. A separate temperature sensor (Pt100 or Pt1000) can be connected to the second analog input. This can then be used to display the temperature of the medium and, if required, monitor it by means of a limit switch. During programming, the displays provide comments on the inputs. A great variety of control tasks can be handled by the various output options (relay contacts and / or analog outputs). The two relay “make” contacts that are provided on the instrument as standard can be configured as a limit controller and / or pulse width or pulse frequency controllers, or as a modulating controller. To obtain analog (continuous) controller outputs, the optional analog outputs must be configured accordingly. All controller outputs can be configured for a P, PI, PD or PID control action. In the basic version, the instrument provides two relay “make” contacts and one logic output (0/5V). Two additional outputs can be, according to choice, fitted with relay changeover contacts and / or analog outputs (process value output or analog controller output), or with a serial interface (Profibus-DP or MODbus / Jbus protocol) and / or a supply for 2-wire transmitters.

### Block structure

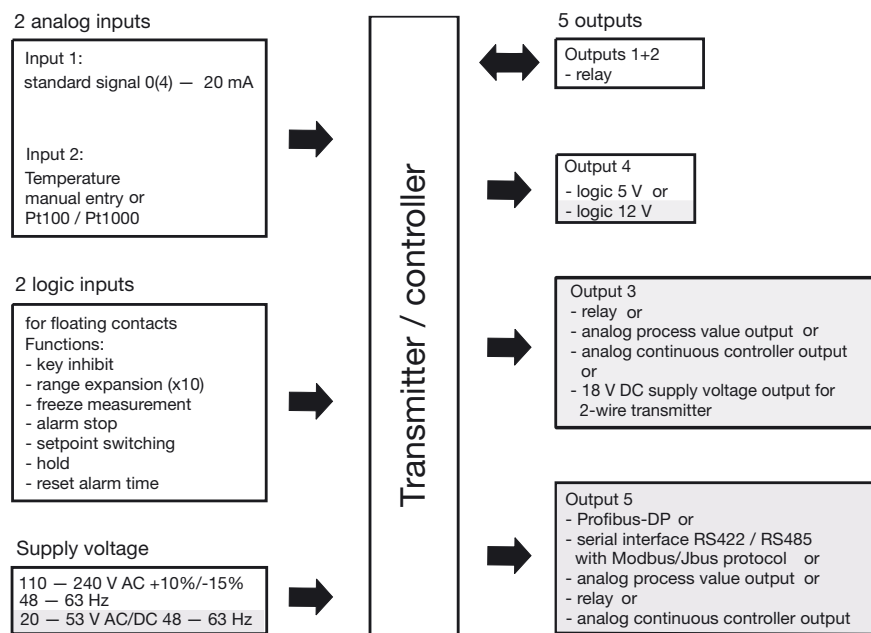

extra code / option



Type 202550 / ...



Type 202550 / .../640

### Special features

- Panel-mounting unit, just 96 x 48 x 110 mm
- Display of pH, mV, µS/cm, mS/cm, mg/l, etc.
- 2 isolated process value outputs 0(4) – 20 mA / 0(2) – 10 V, freely selectable and scalable for the main variable or temperature, or proportional controller (option)
- 2 relays as standard, freely programmable as limit controller or P, PI, PID, PD controller with pulse width or pulse frequency output, or as modulating controller
- 2 logic inputs
- OPTION: Profibus-DP or serial interface RS485 / 422 with MODbus / Jbus protocol
- Protection IP65
- Wall-mounting housing, Protection IP65

### Indicator/controller for pH value or redox voltage

- Simple, guided calibration procedure
- Temperature compensation is possible

### Indicator/controller for conductivity

- Calibration procedure for the relative cell constant
- Calibration procedure for the temperature coefficient of the measuring solution
- Temperature compensation is possible

### Indicator/controller for free chlorine, chlorine dioxide, ozone

- Connection of a sensor (according to Data Sheet 20.2630, for example)
- Integrated calibration procedure

### Universal indicator/controller

- Display range is freely scalable from -1999 to 9999 digit
- Different calibration procedures

### Approvals



## Operation

For easy programming and operation, the controller parameters and configuration data are assigned to various levels.

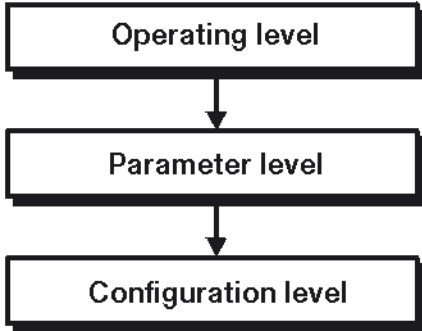

Code words protect the levels from unauthorized access. Membrane keys ensure simple and user-friendly operation. The two LED displays show the parameter symbols and the corresponding values.

### Operating level

The lower display, for example, shows the symbol, the upper display the corresponding value. Setpoints SP1 and SP2 can be altered from the membrane keys.

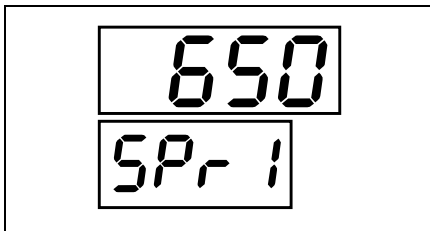

### Parameter level

The controller is adapted to the control loop at this level. The appropriate parameters appear here, with symbol and value. Only those parameters will be indicated which correspond to the configuration of the controller (configuration level).

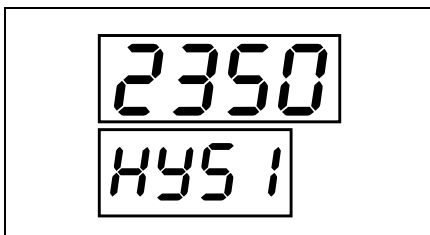

### Configuration level

This level is used to adapt the controller to the control task, or for adaptation of the inputs and outputs.

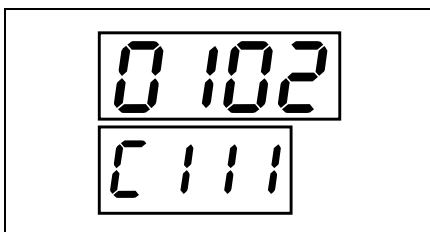

## Indications / controls

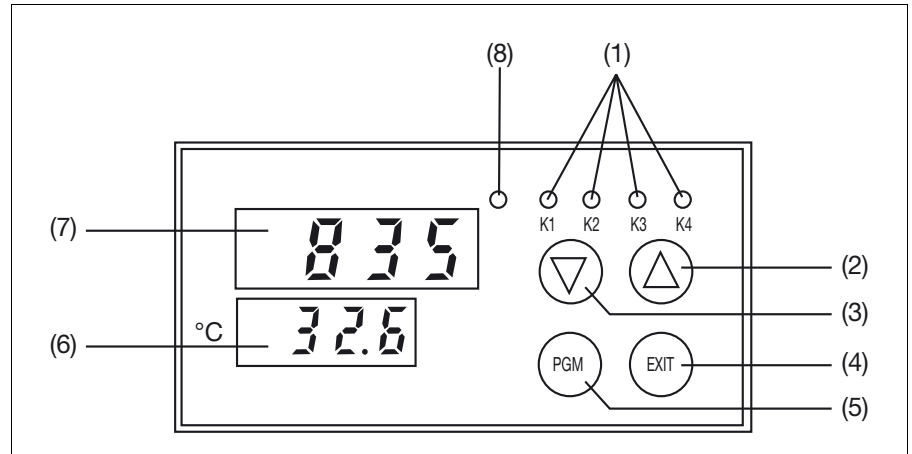

(1) Status indicators (yellow) for outputs 1 to 4	(6) 4-digit temperature display (LED, green, 8mm high)
(2) Increment key for altering parameters or manual operation of relay K2	(7) 4-digit process value indication (LED, red, 13mm high)
(3) Decrement key for altering parameters or manual operation of relay K1	(3) "CAL": Initiating electrode calibration (1-point or 2-point calibration)
(4) EXIT key to leave the levels	(2) + Initiate manual operation or "hold"
(5) PGM key for selection of parameters and confirmation of entries	

## Calibration options

If a transmitter/sensor without integral calibration function is used as a signal source (standard current signal), the dTRANS Az 01 can be configured accordingly, as indicator/controller (for the pH value, for example). It will then offer one of the following calibration options, in accordance with the configuration.

### Indicator/controller for pH value

The electrode parameters of a pH combination electrode are subject to manufacturing tolerances and variations depending on usage. To compensate for these changing electrode parameters, the instrument offers two guided calibration procedures:

#### 1) 2-point calibration (standard)

This method of calibration makes a fresh determination of the **electrode zero and slope** using two solutions with known pH values (e.g. buffer solutions). It should be given preference!

#### 2) 1-point calibration

In 1-point calibration, **only the electrode zero** is freshly determined using a solution with a known pH value (buffer solution). Problems arising from an incorrect electrode slope will not be detected by the user!

This method should only be adopted in cases where the electrode is not subject to significant chemical and mechanical influences.

In addition to the calibration procedures described above, the instrument offers the

facility of manually entering and adjusting the zero point and slope (as determined by a laboratory, for example).

### Indicator/controller for redox voltage

The electrode zero of a redox combination electrode is subject to manufacturing tolerances and variations depending on usage.

The instrument provides the facility for a guided calibration procedure – the 1-point calibration – for the fresh determination of the electrode zero, using a buffer solution or a solution with a known redox voltage.

In addition, the instrument offers the facility of manually entering or adjusting the electrode zero (as determined by a laboratory, for example).

### Indicator/controller for electrolytic conductivity

#### Calibration of the cell constant

Subject to manufacturing tolerances, the cell constant of a conductivity cell may deviate slightly from its nominal (printed) value. In addition, the cell constant may change during operation (due to deposits or wear, for example). This results in a change of the output signal from the cell. The instrument offers the user the possibility of compensating any deviation from the nominal value of the cell constant through **manual entry** (range 80 – 120%) or **automatic calibration** of the relative cell constant  $K_{rel}$ .

#### Calibration of the temperature coefficient $\alpha$

The conductivity of almost all solutions

depends on the temperature. To ensure correct measurement, it is therefore necessary to know both the temperature and the temperature coefficient  $\alpha$  [% per °C] of the measuring solution. The temperature can either be measured automatically, with a Pt100 or Pt1000 temperature probe, or set manually by the user. The temperature coefficient can be determined automatically by the instrument or entered manually, in the range from 0 to 5.5 %/°C

**Indicator/controller for free chlorine, chlorine dioxide and ozone (as per Data Sheet 20.2630)**

The sensor slope is subject to manufacturing tolerances and changes that develop during operation.

The instrument offers the facility for a guided calibration procedure - the 1-point calibration - to freshly determine the sensor slope through comparative measurement.

**Additional functions of the JUMO dTRANS Az 01**

**□ Programmable response of the process value output to underrange/overrange**

On underrange or overrange, the process value output can move to the following operational states:

-4%, 0%, 100% or 110% freely selectable

Example: The instrument is programmed to 4 – 20 mA corresponding to 100 – 500 mV.

It can be set up so that, on falling below 100, the output signal 4 mA (0%) is either maintained or will jump to 3.84 mA (-4%). The 3.84 mA value can then be recognized as “irregular” by a connected PLC.

**□ Bilinear output**

This function divides the signal for the analog process value output into two linear portions (0 – 50% and 50 – 100% of the output signal), with a knee-point at 50% of the output signal. The knee-point of the characteristic can be shifted along the dotted 50% line. The factory setting of 50% produces a straight-line characteristic.

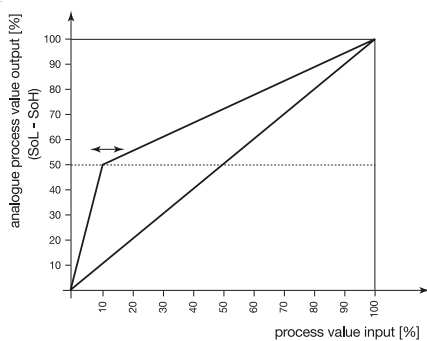

The bilinear characteristic is used when the “normal” measurement range is likely to be frequently exceeded.

Example: The normal measurement range spans 0 – 20  $\mu$ S/cm.

However, measurements of up to 80  $\mu$ S/cm can also occur.

In this case, the range 0 – 100  $\mu$ S/cm will be selected, and the knee-point set at 20% of this range (20% of 100  $\mu$ S/cm corresponds to 20  $\mu$ S/cm).

This results in measurements in the range 0 – 20  $\mu$ S/cm being converted into an output signal 0 – 10 mA.

Measurements in the range 20 – 100  $\mu$ S/cm will be converted into an output signal 10 – 20 mA.

**□ The response of the controller relays to “Hold” can be defined**

“Hold” is initiated either manually, using the keys, by a logic input, or by an alarm event. The outputs of the relays K1 and K2 can move to the following (programmable) states on “Hold”:

0%	Relay de-energized
50% output	For dynamic controllers, 50% of the maximum pulse width or frequency is produced
100% output	Relay is energized, or maximum pulse width/frequency
Output accepted	The present output continues to be produced

**□ In “Manual” mode, the relays K1 and K2 are operated manually, by using the keys.** Either key or switch operation can be selected, by a setting at the parameter level.

Key operation: The relay is switched as long as the key is pressed (e.g. for manual dosing).

Switch operation: The first key stroke switches the relay on, the second switches it off again (toggle action), e.g. for emptying large tanks.

**□ Simulation of the analog process value output**

The process value output (0/2 – 10 V or 0/4 – 20 mA, depending on the setting) can be switched in 10% steps from 0 – 100%, in the manual mode.

Application: “Dry-run” commissioning of the plant (without electrodes, fault search, servicing).

**□ Controller output functions**

Output 1 (relay): Switching, with pulse frequency or pulse width action / limit monitoring / switched off. Switching function can be reversed. MAX / MIN limit comparator.

Output 2 (relay): Switching, with pulse frequency or pulse width action / limit monitoring / MAX limit comparator for temperature input / MIN limit comparator for temperature input / switched off. Switching function can be reversed. MAX / MIN limit comparator.

Output 3, relay or analog process value output: “Hold” / alarm pulse contact; alarm steady contact / MAX limit comparator / MIN limit comparator / output of process value (only for analog process value output) / output of temperature process value (only for analog process value output) / analog controller output (only for analog process value output) / no function.

Output 4, logic output: “Hold” / alarm pulse contact / alarm steady contact / MAX limit comparator / MIN limit comparator / no function.

Output 5, relay or analog process value output: “Hold” / alarm pulse contact; alarm steady contact / MAX limit comparator / MIN limit comparator / output of process value (only for analog process value output) / output of temperature process value (only for analog process value output) / analog controller output (only for analog process value output) / no function.

**Limit comparator (limit monitor)**

A limit-monitoring function can be assigned to the controller outputs 1 to 5 (depending on the instrument version).

For each one, the direction of switching (pulled in on going above/below a limit), pull-in and/or drop-out delay, and a hysteresis can all be defined.

**Interface**

The microprocessor indicator/controller can be optionally fitted with an RS422/RS485 interface. This is used for communication with higher-level systems and integration into a data network. The transmission protocol can be either Profibus-DP or MODbus/Jbus.

**Technical data**

**Inputs**

**Analog input 1**

Input resistance approx. 40  $\Omega$

**Analog input 2**

Resistance thermometer Pt100 or Pt1000, in 2- or 3-wire circuit

-50 to +250°C

Measurement display in •C or •F (option)

**Lead compensation, analog input 2**

The lead resistance can be compensated in software by a correction of the process value. This is not required if the resistance thermometer is connected in a 3-wire circuit. When a resistance thermometer is connected in a 2-wire circuit, lead compensation can be provided by using an external compensation resistor.

**Functional description of logic inputs 1 and 2**

The two standard logic inputs can be operated by floating contacts (relays) from a PLC, or by switches. The following functions can be selected and assigned:

**Key inhibit:** The PLC or a key switch can be used to lock the keys on the instrument, to prevent unauthorized entries being made.

**Setpoint switching:** For comfortable process control. As long as the logic input is not operated, setpoint pair SP1 and SP2 is active. If the appropriately configured logic input is operated, then the second setpoint pair is activated.

**Freeze measurement:** The indicated measurement and the process value output no longer change.

**Hold:** This function can be used (for instance, by a supervisory PLC) to put the instrument into the secure "Hold" state. The response of the controller to "Hold" is as previously defined.

**Hold reversed:** The same function as for "Hold", but when the logic input is open.

**Alarm stop:** The alarm generation via the configured output is reset or prevented, but the alarm LED (e.g. K4) continues to blink as a warning.

**Reset alarm time:** The alarm generation via the configured output is prevented. The alarm delay time is set to zero, but is restarted when the logic input becomes inactive and the start conditions are fulfilled once more.

**Range expansion (x10):** If only a small portion of the measurement range is used, it may be advantageous for the instrument to react to 0 – 10% of the process value by producing 0 – 100% of the output signal.

#### Display and control range

##### pH value

-1.00 to 14.00 pH

##### Redox voltage

-1999 to +1999 mV

##### Conductivity

0 – 9999 mS/cm or  $\mu$ S/cm

0 – 9.999 mS/cm or  $\mu$ S/cm

0 – 99.99 mS/cm or  $\mu$ S/cm

0 – 999.9 mS/cm or  $\mu$ S/cm

##### Universal display

-1999 to 9999 digit

-1.999 to 9.999 digit

-19.99 to 99.99 digit

-199.9 to 999.9 digit

##### Deviation from characteristic

$\leq 0.15\%$  per 10 °C

##### Temperature display

-50 to +250°C (can be switched to °F)

##### Deviation from characteristic

$\leq 0.1\%$  per 10 °C

#### Outputs

2 relay outputs, 1 logic output, 1 analog process value output or 1 additional relay, and 1 serial interface are available.

##### 1. Relay, output 1 / 2 (standard)

Make contact (n.o., can also be configured as n.c. break contact)

contact rating: 3A, 250V AC

with resistive load

contact life:

$> 5 \times 10^5$  operations at rated load

##### 2. Logic output, output 4

0/5V  $R_{load} \geq 250\Omega$

0/12V  $R_{load} \geq 650\Omega$  (option)

##### 3. Process value output, output 3 or 5 (option)

freely configurable:

0(2) – 10V  $R_{load} \geq 500\Omega$  or

0(4) – 20mA  $R_{load} \geq 500\Omega$

electrically isolated from the inputs:

$\Delta U \leq 30V$  AC or

$\Delta U \leq 50V$  DC

##### Deviation from characteristic of output signal

$\leq 0.25\%$ ,  $\pm 50$  ppm per °C

##### 4. Relay, output 3 or 5 (option)

(only for instruments without a process value output)

changeover contact

contact rating: 3A, 250V AC

with resistive load

contact life:

$> 5 \times 10^5$  operations at rated load

##### 5. Interface RS422 / RS485, output 3 or 5 (option)

electrically isolated

##### Baud rate

4800 / 9600bps

##### Protocol

MODbus/Jbus or Profibus-DP

##### 6. Supply for 2-wire transmitter (output 5, option)

18 V DC, max. 30 mA

#### General controller data

##### A/D converter

resolution  $> 15$  bit

##### Controller type

Limit controller and / or pulse width or pulse frequency controller, proportional controller or modulating controller, freely configurable and selectable

##### Control action

configurable as P, PI, PID or PD.

##### Sampling time

210msec

##### Measurement circuit monitoring

Input 1: out-of-range

Input 2: out-of-range, probe short-circuit,

probe break

The outputs move to a defined (configurable) status.

##### Data backup

EEPROM

##### Supply voltage

110 – 240 V AC  $+10\%/-15\%$ ,

48 – 63 Hz or

20 – 53VAC/DC, 0 – 63/0 Hz

##### Power consumption

approx. 8V A

##### Electrical connection

via gold-plated faston connectors to DIN 46 244/A; 4.8mm x 0.8mm

##### Permissible ambient temperature

0 to  $+50^\circ\text{C}$

##### Permissible

##### ambient temperature limits

-10 to  $+55^\circ\text{C}$

##### Permissible storage temperature

-40 to  $+70^\circ\text{C}$

##### Climatic conditions

rel. humidity  $\leq 75\%$ , no condensation

##### Enclosure protection

to EN 60 529

front IP65 / rear IP20

##### Electrical safety

to EN 61 010

clearance and creepage distances for

- overvoltage category II

- pollution degree 2

##### Electromagnetic compatibility

to EN 61 326

radiated interference: Class B

interference immunity: to industrial requirements

##### Housing

Panel-mounting housing in conductive plastic

to DIN 43 700, base material ABS

with plug-in controller module

##### Operating position

unrestricted

##### Weight

##### Switchgear cabinet unit (basic version)

approx. 320g

##### Wall-mounting housing (extra code /640)

approx. 1400g

#### Option

##### Wall-mounting housing

extra code /640

On request, the JUMO dTRANS Az 01 can be supplied built into a surface-mounting housing. The housing is suitable for wall-mounting or mounting on a DIN rail as per EN 50 022, 35 x 7.5 mm.

The housing is sturdy and provides IP67 protection for the built-in instrument. It is fitted with six cable glands. Unused cable glands can be tightly sealed using the blind grommets that are included in the delivery.

The electrical connection is made via screw terminals.

(wire cross-section up to 2.5 mm<sup>2</sup>).

##### Standard accessories

- 2 fixing items (not with extra code /640 (wall-mounting housing))

- 1 Operating Instructions B20.2550.0.1

## Parameters

Parameter	Display	Value range	Comments
Alarm tolerance pH / redox / conductivity <sup>1</sup>	AL1	0.00 – 99.99 pH 0000 – 9999 mV 0.000 – 9999 <sup>2</sup>	The alarm is only generated when the level (setpoint + alarm tolerance) has been passed, and the alarm delay time has elapsed (only effective for pulse width / pulse frequency controllers. It is internally fixed at 0 for limit controllers.
Alarm delay	AL2	0 – 6000 sec	Delay time before the alarm contact is activated
Proportional band <sup>1</sup> pH / redox / conductivity <sup>1</sup>	Pb1	0.01 – 99.9 pH 1 – 9999 mV 1 – 9999 <sup>2</sup>	Influences the P action of the controller
Proportional band 2 pH / redox / conductivity <sup>1</sup>	Pb2	0.01 – 99.9 pH 1 – 9999 mV 1 – 9999 <sup>2</sup>	
Derivative time 1	dt1	0 – 9999 sec	Influences the D action of the controller If dt = 0, the controller has no D action.
Derivative time 2	dt2		
Reset time 1	rt1		Influences the I action of the controller If rt = 0, the controller has no I action.
Reset time 2	rt2		
Minimum ON time 1 (for limit controller or pulse width controller) or minimum pulse width 1 (for pulse frequency controller)	tr1	0.2 – 999.9 sec	Determined by the technical data of the dosing device (solenoid valve, dosing pump)
Minimum ON time 2 (for limit controller or pulse width controller) or minimum pulse width 2 (for pulse frequency controller)	tr2		
Switching differential 1 pH / redox / conductivity <sup>1</sup>	HYS1	0.01 – 99.9 pH 1 – 9999 mV 1 – 9999*	Defines the switch-off point for the control contacts
Switching differential 2 pH / redox / conductivity <sup>1</sup>	HYS2		
Switching differential 3 pH / redox / conductivity <sup>1</sup>	HYS3		
Switching differential 4 pH / redox / conductivity <sup>1</sup>	HYS4		
Switching differential 5 pH / redox / conductivity <sup>1</sup>	HYS5		
Pull-in delay 1	Ond1	0.2 – 999.9 sec	Delay time before the contact is activated
Pull-in delay 2	Ond2		
Pull-in delay 3	Ond3		
Pull-in delay 4	Ond4		
Pull-in delay 5	Ond5		
Drop-out delay 1	Ofd1	0.2 – 999.9 sec	Delay time until the contact moves back to the initial position
Drop-out delay 2	Ofd2		
Drop-out delay 3	Ofd3		
Drop-out delay 4	Ofd4		
Drop-out delay 5	Ofd5		
Maximum pulse frequency 1	Fr1	0 – 150 pulse / min	Maximum frequency of pulses (operating a dosing pump, for instance)
Maximum pulse frequency 2	Fr2		
Pulse period 1	Cy1	1.0 – 999.9 sec	The period in which a pulse is modulated
Pulse period 2	Cy2		
Output level limit, output 1	Y1	0 – 100%	The maximum output level for a pulse width / pulse frequency controller
Output level limit, output 2	Y2		
Actuator time	tt	15 – 3000 sec	For modulating controller

<sup>1</sup> according to dimensional unit

<sup>2</sup> unit as per configuration

# Connection diagram

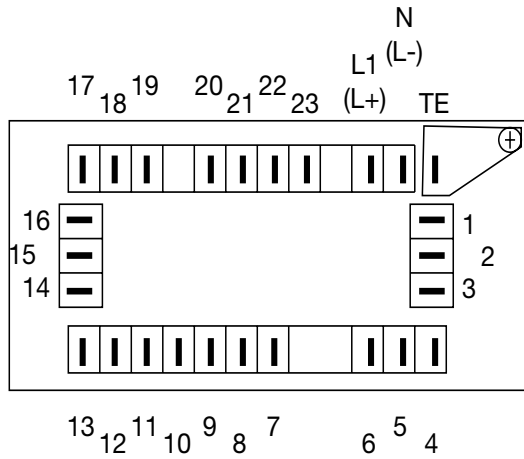

Rear view with faston connectors

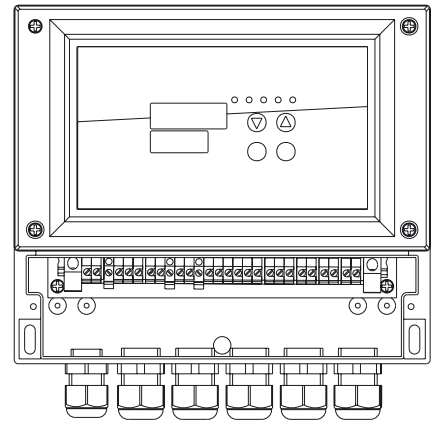

Wall-mounting housing (extra code /640) with terminal strip

Outputs	K	Terminal assignments	Symbol
Relay 1 (K1) Status indication LED K1	1	23 common 22 make (n.o.)	
Relay 2 (K2) Status indication LED K2	2	21 common 20 make (n.o.)	
Relay 3 (K3) Status indication LED K3	3	16 break (n.c.) 15 common 14 make (n.o.)	
<b>or</b> analog process value output (electrically isolated)		15 - 14 +	
Supply for 2-wire transmitter	3	15 + 14 -	
Logic output 1 (K4) Status indication LED K4	4	19 - 17 +	
Relay 4 (K5) No status indication	5	3 break (n.c.) 2 common 1 make (n.o.)	
<b>or</b> analog process value output (electrically isolated)		2 - 1 +	
Supply for 2-wire transmitter	5	2 - 3 +	

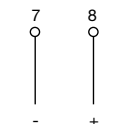
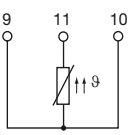
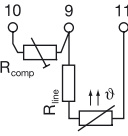
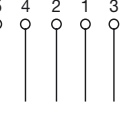
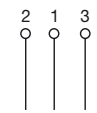
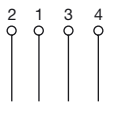
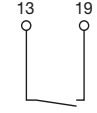
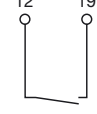
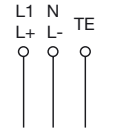
Inputs		Terminal assignments		Symbol	
Input for standard signal $I_x$ (0(4) – 20 mA)		7 - 8 +			
Resistance thermometer in 3-wire circuit		9 10 11			
Resistance thermometer in 2-wire circuit		10 9 11			
<b>Serial interface RS422</b> (option)	RxD	5 4	RxD + RxD -	receive data	
	TxD	2 1	TxD + TxD -	transmit data	
	GND	3	GND		
<b>Serial interface RS485</b> (option)	+ -	2 1	TxD/RxD + TxD/RxD -	receive data / transmit data	
	GND	3	GND		
<b>Serial interface Profibus-DP</b> (option)	VP	4	supply voltage-plus (P5V)		
	RxD/TxD-P	2	receive/transmit data-positive, B conductor		
	RxD/TxD-N	1	receive/transmit data-negative, A conductor		
	DGND	3	ground for data transmission		
<b>Logic input 1</b>		13 19			
<b>Logic input 2</b>		12 19			
<b>Supply voltage</b> see nameplate	AC/ DC	AC: L1 phase/line N neutral TE technical earth	DC: L + L -		



**Dimensions**

Type 202550/...

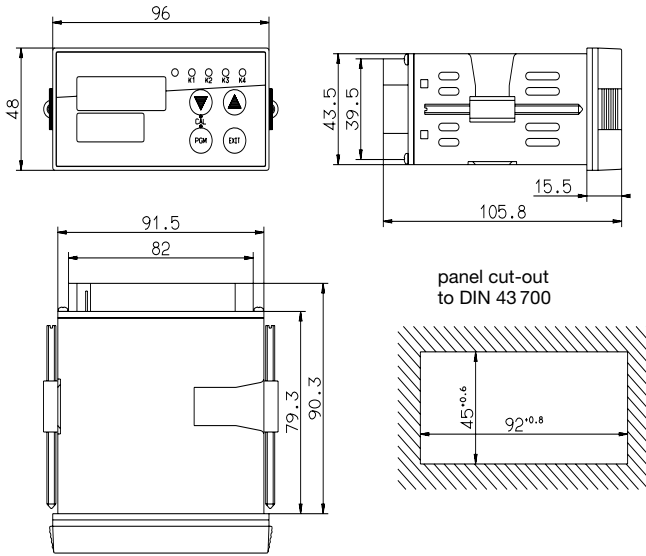

**Panel cut-out to DIN 43 700  
close mounting (minimum dimensions)**

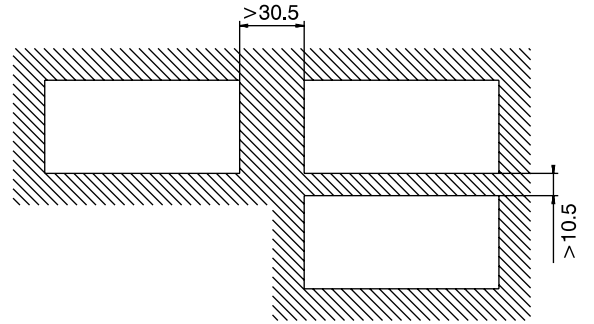

**Option**

Surface-mounting housing, extra code /640, Protection IP67

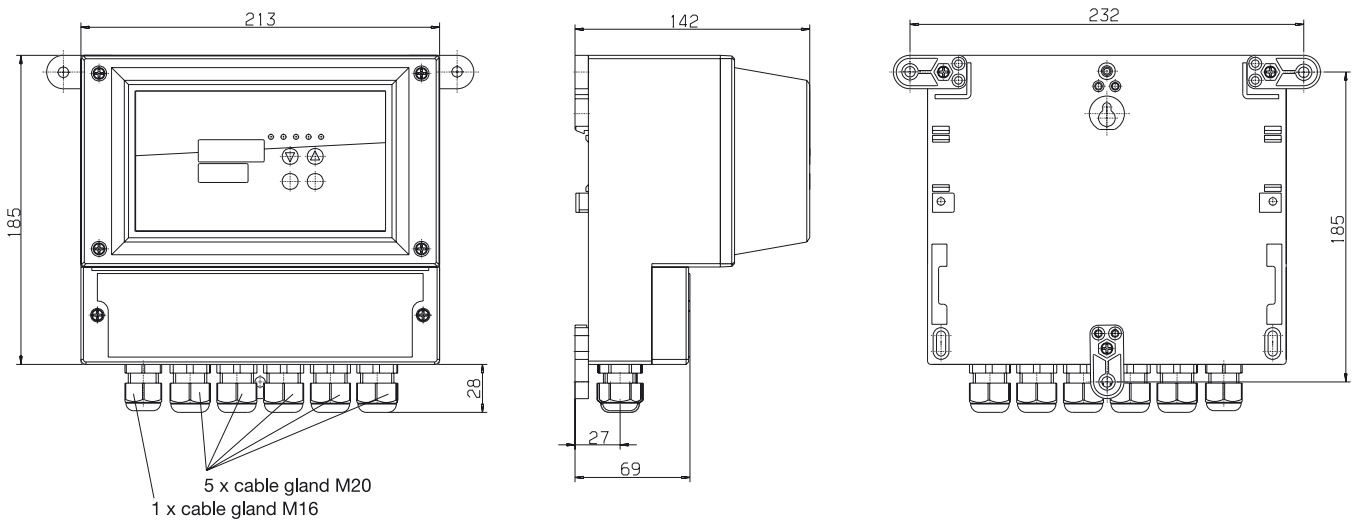



**Type designation**

**(1) Basic type**

202550 JUMO dTRANS Az 01  
Microprocessor indicator / controller for analytical measurement

**(2) Basic type extensions**

10 Limit controller\*

**(3) Inputs**

660 0/4 – 20 mA front panel print: pH and mV, °C  
 661 0/4 – 20 mA front panel print: mV, °C  
 662 0/4 – 20 mA front panel print: mS/cm and µS/cm, °C  
 664 0/4 – 20 mA front panel print: none, °C  
 665 0/4 – 20 mA front panel print: mg/l, °C

**(4) Output I**

000 no output  
 140 supply for 2-wire transmitter  
 310 relay, changeover contact  
 888 process value output, freely configurable

**(5) Output II**

000 no output or interface  
 140 supply for 2-wire transmitter<sup>1</sup>  
 310 relay, changeover contact<sup>1</sup>  
 888 process value output, freely configurable<sup>1</sup>

**(6) Supply voltage**

22 20 – 53 V AC/DC ±0%, 48 – 63/0 Hz  
 23 110 – 240 V AC +10%/-15%, 48 – 63 Hz

**(7) Interface**

00 no serial interface  
 54 serial interface RS422/485<sup>1</sup>  
 64 serial interface Profibus-DP<sup>1</sup>

**(8) Extra codes**

000 no extra codes  
 015 logic output 0/12 V DC, instead of standard 0/5 V DC  
 640 surface-mounting housing for wall-mounting or DIN rail mounted, Protection IP67

**\*Generally**

on all controllers of the 202550 series, the user can freely select the following configurations:

- Controller off
- Limit controller
- Pulse width controller with P, PI, PD, PID control action
- Pulse frequency controller with P, PI, PD, PID control action
- Modulating controller

<sup>1</sup> If output II (4) = "310" "140" or "888", then the interface option (6) is not possible (or the other way round)!

	(1)	(2)	(3)	(4)	(5) <sup>1</sup>	(6)	(7) <sup>1</sup>	(8)
<b>Order code</b>	202550	/ 10	-		,		-	
<b>Order example</b>	202550	/ 10	-	660	,	888	-	310 - 23 - 00 / 000

**Optional accessories 1** (switchgear cabinet units)

Designation	Sales No.
Bracket for C-rail	70/00375749
Blank cover 96 x 48 mm	70/00069680

**Optional accessories 2** (wall-mounting units)

Designation	Sales No.
Pole clamp, 60 mm dia. (clamping area: 50 - 70 mm dia.)	20/00437485
Pole clamp, 120 mm dia. (clamping area: 100 - 120 mm)	20/00437486

# Application example

## Indicator for pH

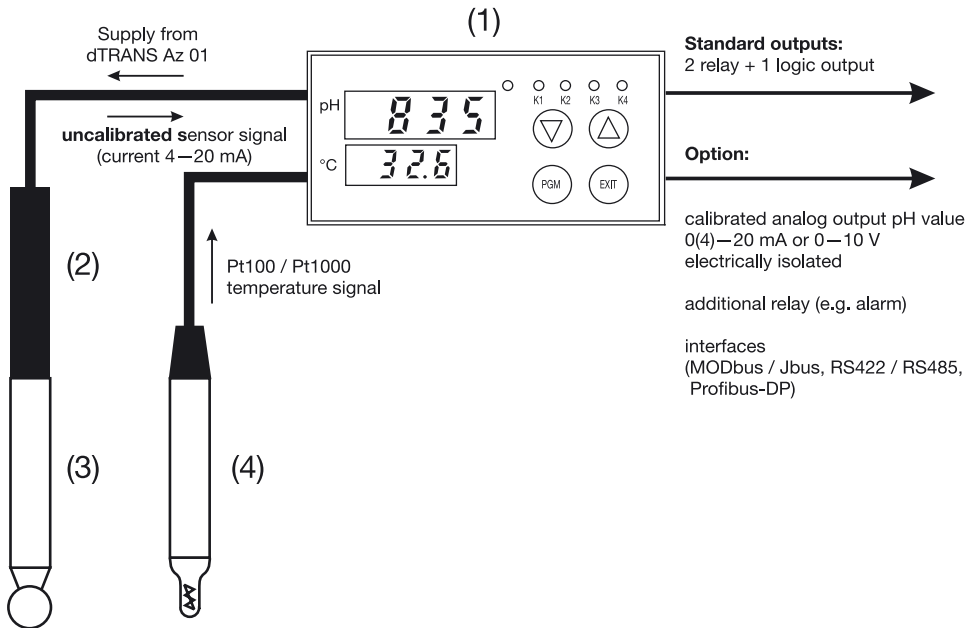

- (1) Indicator / controller for pH, type 202550 with integrated supply for a 2-wire transmitter
- (2) 2-wire transmitter, type 202701
- (3) pH combination electrode, e.g. type 2GE-2G-U-1
- (4) Compensation thermometer, type 2K-2

### Advantages:

- long cable lengths can be covered, with low interference
- reduced wiring requirements, since supply for 2-wire transmitter is integrated in indicator
- calibration facility in indicator
- humidity problems reduced to a minimum during calibration

## Indicator for free chlorine, chlorine dioxide or ozone

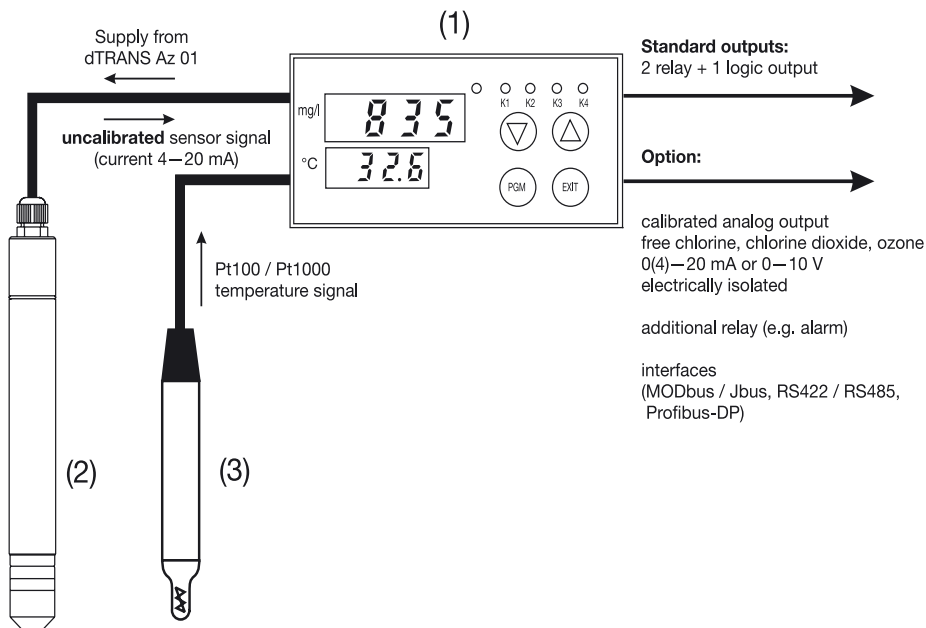

- (1) Universal indicator / controller, type 202550 with integrated supply for a 2-wire transmitter
- (2) Measuring cell for free chlorine, type 202630
- (3) Compensation thermometer, type 2K-2