

JUMO mTRON T

Measuring, Control, and Automation System

Analog Input Module 8-Channel

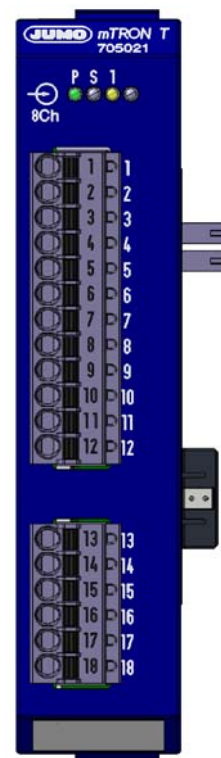

Operating Manual



70502100T90Z001K000

V2.00/EN/00575627

1	Introduction	.5
1.1	Available technical documentation	5
1.1.1	General information	5
1.1.2	Base units	5
1.1.3	Input/output modules	6
1.1.4	Special modules	6
1.1.5	Operating, visualization, recording	7
1.1.6	Power supply units	7
1.2	Safety information	8
1.2.1	Warning symbols	8
1.2.2	Note signs	8
1.2.3	Intended use	9
1.2.4	Qualification of personnel	9
1.3	Acceptance of goods, storage, and transport	10
1.3.1	Checking the delivery	10
1.3.2	Notes on storage and transport	10
1.3.3	Returning goods	10
1.3.4	Disposal	11
1.4	Identifying the Device Version	12
1.4.1	Nameplates	12
1.4.2	Order details	13
1.4.3	Scope of delivery	13
1.4.4	General accessories	14
2	Description	.15
2.1	Brief description	15
2.2	Block diagram	15
3	Installation	.17
3.1	General information on installation/dismounting	17
3.2	Installation/dismounting on DIN rail	18
3.2.1	Input/output modules	19
3.3	Replacing module inserts	22
3.3.1	Input/output modules	22
3.4	Dimensions	24
4	Electrical connection	.25
4.1	Installation notes	25
4.2	Electrical isolation	26
4.3	Connection diagram	27
4.3.1	Display and connection elements	27
4.3.2	Analog inputs	28
4.3.3	Digital input	28

Contents

4.4	Functional test	28
5	Operation	29
5.1	Display and connection elements	29
5.2	LED displays	30
5.2.1	Display modes	30
5.2.2	System states and errors	31
6	Configuration	33
6.1	Digital selector	33
6.2	Analog inputs	34
6.2.1	Alarms	36
6.2.2	Fine adjustment	38
6.3	Digital input	40
6.4	NV connecting list	42
6.4.1	Digital signals (overview)	44
6.4.2	Replacement values (overview)	50
7	Online parameters	51
7.1	Calibrate / test	51
7.1.1	Analog input	51
7.1.2	Digital input	52
7.1.3	LED test	53
7.1.4	Calibration constants	54
7.1.5	Versions	54
8	Appendix	55
8.1	Technical data	55
8.1.1	Analog inputs	55
8.1.2	Digital input	55
8.1.3	Electrical data	56
8.1.4	Case and ambient conditions	56
8.1.5	Approval/approval marks	57
8.2	China RoHS	58

1.1 Available technical documentation

The documents specified below are available for the measuring, control, and automation system (previous document number in parentheses).

1.1.1 General information

Product	Type of documentation	No.	Printed	PDF file
Measuring, control, and automation system	Data sheet	70500000T10...	-	X
	System manual ¹	70500000T90... (B 705000.0)	X	-
	Setup program manual	70500000T96... (B 705000.6)	-	X
	System description ²	70500000T98... (B 705000.8)	-	X

¹ Accessory subject to charge

² Includes an overview of the purpose and content of all documents

1.1.2 Base units

Product	Type of documentation	No.	Printed	PDF file
Central processing unit	Data sheet	70500100T10...	-	X
	Operating manual	70500100T90... (B 705001.0)	-	X
	Modbus interface description	70500100T92... (B 705001.2.0)	-	X
	PROFIBUS-DP interface description	70500103T92... (B 705001.2.3)	-	X
	digiLine interface description	70500106T92...	-	X
	Installation instructions	70500100T94... (B 705001.4)	X	X
	CODESYS OPC server operating manual	70500151T90... (B 705001.5.1)	-	X
	Process engineering application operating manual	70500152T90...	-	X
	Operating manual Thyristor power controller (type 70906x; integration in the measuring, control, and automation system)	70500153T90...	-	X

1 Introduction

1.1.3 Input/output modules

Product	Type of documentation	No.	Printed	PDF file
Multichannel controller module	Data sheet	70501000T10...	-	X
	Operating manual	70501000T90... (B 705010.0)	-	X
	Installation instructions	70501000T94... (B 705010.4)	X	X
Relay module 4-channel	Data sheet	70501500T10...	-	X
	Operating manual	70501500T90... (B 705015.0)	-	X
	Installation instructions	70501500T94... (B 705015.4)	X	X
Analog input module 4-channel	Data sheet	70502000T10...	-	X
	Operating manual	70502000T90... (B 705020.0)	-	X
	Installation instructions	70502000T94... (B 705020.4)	X	X
Analog input module 8-channel	Data sheet	70502100T10...	-	X
	Operating manual	70502100T90... (B 705021.0)	-	X
	Installation instructions	70502100T94... (B 705021.4)	X	X
Analog output module 4-channel	Data sheet	70502500T10...	-	X
	Operating manual	70502500T90...	-	X
	Installation instructions	70502500T94...	X	X
Digital input/output module 12-channel	Data sheet	70503000T10...	-	X
	Operating manual	70503000T90... (B 705030.0)	-	X
	Installation instructions	70503000T94... (B 705030.4)	X	X

1.1.4 Special modules

Product	Type of documentation	No.	Printed	PDF file
Router module	Data sheet	70504000T10...	-	X
	Installation instructions	70504000T94... (B 705040.4)	X	X

1.1.5 Operating, visualization, recording

Product	Type of documentation	No.	Printed	PDF file
Multifunction panel 840	Data sheet	70506000T10...	-	X
	Operating manual	70506000T90... (B 705060.0)	-	X
	Modbus interface description	70506000T92... (B 705060.2.0)	-	X
	Installation instructions	70506000T94... (B 705060.4)	X	X
Operating panels	Data sheet	70506500T10...	-	X
	Operating manual	70506500T90...	-	X

1.1.6 Power supply units

Product	Type of documentation	No.	Printed	PDF file
24 V power supply units	Data sheet	70509000T10...	-	X
	Operating instructions QS5.241		X	-
	Operating instructions QS10.241		X	-

1 Introduction

1.2 Safety information

1.2.1 Warning symbols



DANGER!

This symbol indicates that **personal injury caused by electrical shock** may occur if the respective precautionary measures are not carried out.



WARNING!

This symbol in connection with the signal word indicates that personal injury may occur if the respective precautionary measures are not carried out.



CAUTION!

This symbol in connection with the signal word indicates that **damage to assets or data loss** will occur if the respective precautionary measures are not taken.



CAUTION!

This symbol indicates that **components could be destroyed** by electrostatic discharge (ESD = Electro Static Discharge) if the respective cautionary measures are not taken. Only use the ESD packages intended for this purpose to return device inserts, assembly groups, or assembly components.



READ DOCUMENTATION!

This symbol – placed on the device – indicates that the associated **device documentation has to be observed**. This is necessary to recognize the kind of the potential hazards as well as the measures to avoid them.

1.2.2 Note signs



NOTE!

This symbol refers to **important information** about the product, its handling, or additional use.



REFERENCE!

This symbol refers to **further information** in other sections, chapters, or manuals.



FURTHER INFORMATION!

This symbol is used in the tables and refers to **further information** in connection with the table.



DISPOSAL!

This device and the batteries (if installed) must not be disposed in the garbage can after use! Please ensure that they are disposed properly and in an **environmentally friendly manner**.

1.2.3 Intended use

The modules described are intended for measuring, control, and automation tasks in an industrial environment, as described in the technical data. Other uses or uses beyond those defined are not viewed as intended uses.

The modules are built according to the relevant standards and directives as well as the applicable safety regulations. Nevertheless, incorrect use may lead to bodily injury or property damage.

To avoid danger, the modules may only be used:

- For the intended use
- When in good order and condition
- When taking into account the technical documentation provided

Even if a module is used correctly and according to the intended use, it may still cause application-related dangers (e.g. due to missing safety devices or incorrect settings).

1.2.4 Qualification of personnel

This document contains the necessary information for the intended use of the modules to which it relates.

It is intended for technically qualified personnel who have received special training and have the appropriate knowledge in the field of automation technology (measuring, process, and control technology).

The appropriate level of knowledge and the technically fault-free implementation of the safety information and warnings contained in the technical documentation provided are prerequisites for risk-free mounting, installation, and startup as well as for ensuring safety when operating the described modules. Only qualified personnel have the required specialist knowledge to correctly interpret and implement the safety information and warnings contained in this document in specific situations.

1 Introduction

1.3 Acceptance of goods, storage, and transport

1.3.1 Checking the delivery

- Ensure that the packaging and contents are not damaged
- Check that the delivery is complete using the delivery papers and the order details
- Inform the supplier immediately if there is any damage
- Store damaged parts until clarification is received from the supplier

1.3.2 Notes on storage and transport

- Store the module in a dry and clean environment. Observe the admissible ambient conditions (see "Technical data")
- The transport of the module is to be shockproof
- The original packaging provides optimum protection for storage and transport

1.3.3 Returning goods

In the event of repair, please return the module in a clean and complete state. Use the original packaging to return goods.

Accompanying letter for repair

Please include the completed accompanying letter for repair when returning goods. Do not forget to state the following:

- Description of the application and
- Description of the error that has occurred

The accompanying letter for repair can be downloaded online from the manufacturer's website (use the search function if necessary).

Protection against electrostatic discharge (ESD)

(ESD = electrostatic discharge)

To prevent damage from ESD, electronic modules or components must be handled, packaged, and stored in an ESD-protected environment. Measures against electrostatic discharge and electrical fields are described in DIN EN 61340-5-1 and DIN EN 61340-5-2 "Protection of electronic devices from electrostatic phenomena".

When returning electronic modules or components, please note the following:

- Sensitive components must only be packaged in an ESD-protected environment. Workspaces such as this divert electrostatic charges to ground in a controlled manner and prevent static charges due to friction capacities.
- Only use packaging for ESD-sensitive modules/components. These must consist of conductive plastics.

No liability can be assumed for damage caused by ESD.

**CAUTION!**

Electrostatic charges occur in non-ESD protected environments.
Electrostatic discharges can damage modules or components.
For transport purposes, use only the ESD packaging provided.

1.3.4 Disposal

Disposing of the device

**DISPOSAL!**

Devices and/or replaced parts should not be placed in the refuse bin at the end of their service life as they consist of materials that can be recycled by specialist recycling plants.

Dispose of the device and the packaging material in a proper and environmentally friendly manner.

For this purpose, observe the country-specific laws and regulations for waste treatment and disposal.

Disposing of the packaging material

The entire packaging material (cardboard packaging, inserts, plastic film, and plastic bags) is fully recyclable.

1 Introduction

1.4 Identifying the Device Version

1.4.1 Nameplates

Position

The nameplate (B) is affixed to the module case.

An additional nameplate with reduced information is located on the module insert (A). This duplicate identification is important when replacing a module insert or retrofitting optional modules.

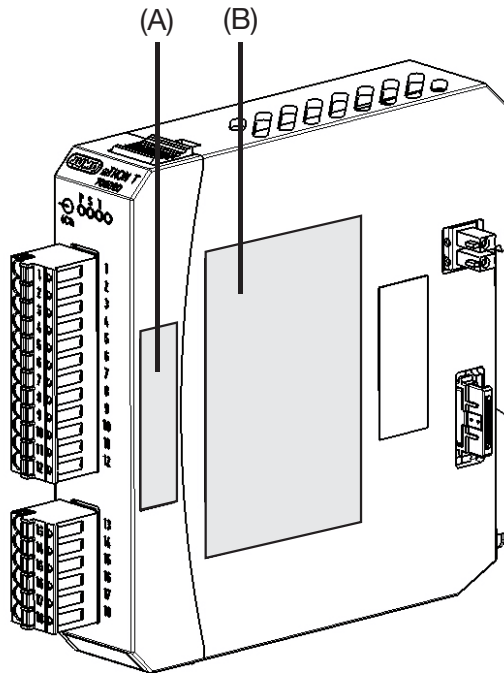

Contents

It contains important information. This includes:

Description	Designation on the name-plate	Example
Device type (A + B)	Type	705021/36
Part no. (B)	TN	00XXXXXX
Fabrication number (A + B)	F-Nr	0070033801211010006
Voltage supply (B)	-	DC 24 V +25/-20 %

Device type

Compare the specifications on the nameplate with the order.

Identify the supplied device version using the order details of the respective module.

Part no. (TN)

The part no. clearly identifies an article in the catalog. It is important for communication between the customer and the sales department.

Fabrication no. (F-Nr)

Among other things, the fabrication number contains the date of production (year/week).

Example: F-Nr = 00700338012**1101**0006

The figures concerned are in positions 12, 13, 14, and 15 (from the left).

The device was therefore produced in the 1st calendar week of 2011.

1.4.2 Order details

(1) Basic type	
705021	Analog input module 8-channel
(2) Voltage supply	
36	DC 24 V +25/-20 %
(3) DNV GL approval	
000	Without approval
062	With DNV GL approval ¹

¹ The power supply unit used must also have a DNV GL or GL type approval (e.g. type 705090).

Order code **(1)** **(2)** **(3)**
 / /
Order example 705021 / 36 / 000

1.4.3 Scope of delivery

1 analog input module, 8-channel
1 Installation Instructions

1 Introduction

1.4.4 General accessories

Description	Part no.
JUMO mTRON T system manual, English	00575577
Setup program with program editor JUMO mTRON T (on MiniDVD), incl. USB cable (A-plug to mini-B-plug, 3 m)	00569494
Program editor JUMO mTRON T (on MiniDVD), incl. USB cable (A-plug to mini-B-plug, 3 m)	00622333
PCA3000/PCC JUMO software package	00431884
PC Evaluation Software PCA3000	00431882
Release automatic print for PC Evaluation Software PCA3000	00505548
PCA Communication Software PCC	00431879
Plant Visualization Software JUMO SVS3000: See data sheet 700755	-
USB cable A-plug mini-B-plug 3 m	00506252

Content of the Mini-DVD:

- Setup program with program editor JUMO mTRON T in case of part no. 00569494
- Program editor JUMO mTRON T in case of part no. 00622333
- CODESYS programming software (free version)
- CODESYS Repository Package - Operating panels (free version)
- GSD file JUMO mTRON T - CPU (free version)
- PC Evaluation Software PCA3000 (30-day trial version)
- PCA Communication Software PCC (30-day trial version)
- Documentation in PDF format

2.1 Brief description

The analog input module 8-channel is equipped with eight analog inputs for RTD temperature probes in 2-wire circuit as well as one digital input (DC 0/24 V). The analog inputs are not electrically isolated from each other. The digitized input values/states are available in the system for further processing.

LEDs are used to indicate applied voltage supply, the module operating status, as well as the digital input status.

A setup program or the multifunction panel 840 can be used to comfortably configure the analog input module.

For service work, the module insert can be easily pulled out of the case at the front. The case including the bus PCB remains mounted on the DIN rail.

2.2 Block diagram

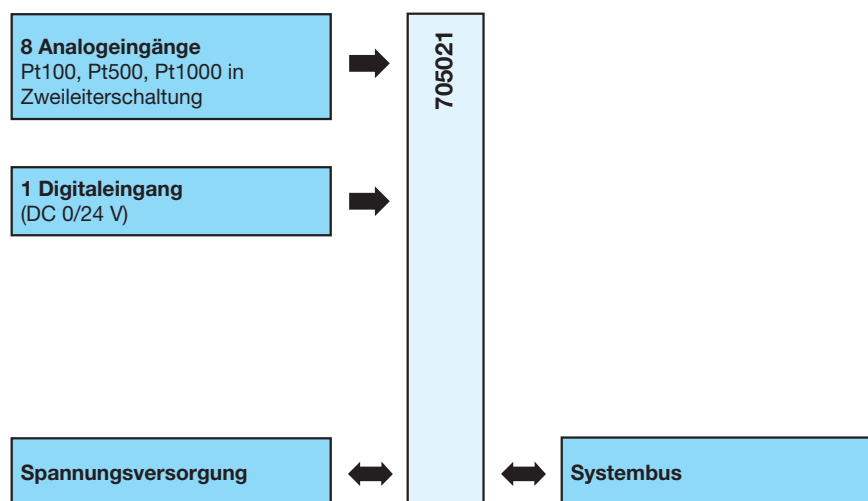

2 Description

3.1 General information on installation/dismounting

**DANGER!**

With multichannel controller module 705010 and relay module 705015, the load circuits from relay or solid state relay outputs can be operated with a dangerous electrical voltage (e.g. 230 V).

There is a risk of electric shock.

Prior to the installation/dismounting of these modules or the removal of the module insert, the load circuits are to be disconnected from the voltage and the terminal strips are to be removed from the module. This work must only be performed by qualified personnel.

**WARNING!**

The modules must never be installed in areas with an explosion hazard.

There is the risk of an explosion.

The entire system must only be used outside of areas with an explosion hazard.

Mounting site

All modules have protection type IP20 and are only intended for use in fireproof control cabinets or switch boxes. The mounting site should be virtually vibration-free. Electromagnetic fields caused by equipment such as motors or transformers should be avoided.

Multifunction panel 840 has protection type IP67 at the front and is intended for installation in a panel cut-out. The rear has protection type IP20.

Climatic conditions

The ambient temperature and the relative humidity at the mounting site must correspond to the technical data. Aggressive gases and vapors have a negative effect on the operating life of the modules. The mounting site must be free from dust, powder, and other suspended matter so that the cooling slots do not become blocked.

DIN rail

All modules are mounted on a DIN rail according to DIN EN 60715 (35 mm × 7.5 mm × 1 mm). For reasons of stability, the spacing of the fastening screws for the DIN rail should not exceed 200 mm. The minimum distances for the modules that are specified in the module-specific installation or operating instructions must be observed.

Installation position

The DIN rail should be mounted horizontally so that all modules are arranged vertically. Otherwise the admissible ambient temperature range will be restricted.

Space requirement

The modules require the minimum distances shown in the following figure for the purpose of installation/dismounting and for future maintenance or replacement. In the event of shorter distances the minimum bending radius of the cables, the performance of the electrical installation, and the clear arrangement of the plant are no longer guaranteed.

3 Installation

Minimum distances

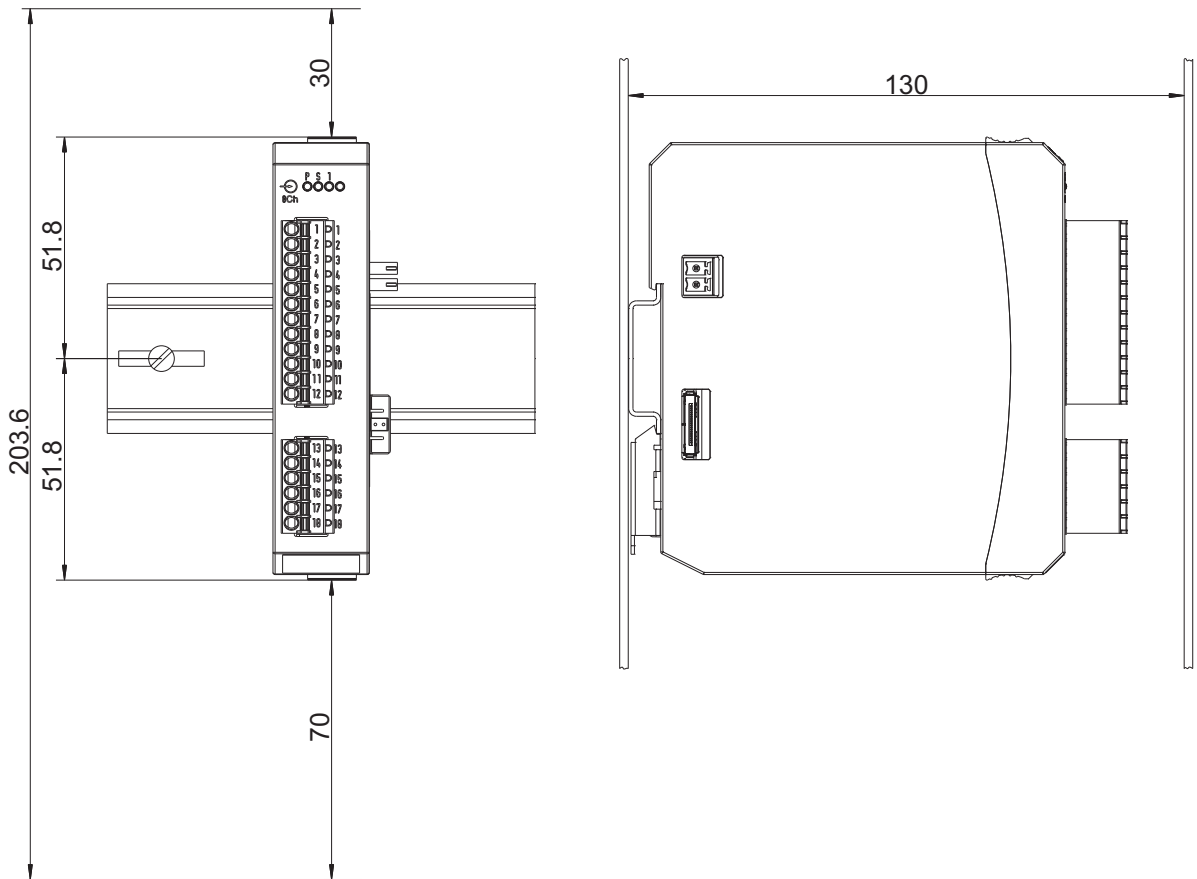

3.2 Installation/dismounting on DIN rail

All modules in the system are intended for installation on a DIN rail according to DIN EN 60715 (35 mm × 7.5 mm × 1 mm).

The following must always be installed on the left, at the start of the DIN rail:

- A central processing unit *or*
- A router module

These modules connect the input/output modules to the voltage supply and the system bus.



NOTE!

To determine the required minimum width of the DIN rail, the widths of the individual modules are to be added (see technical data of the modules in the respective data sheet or the module-specific installation instructions).

The widths of the cover (17.5 mm) and both end brackets (each 9.5 mm) should also be taken into consideration: $17.5 \text{ mm} + 2 \times 9.5 \text{ mm} = 36.5 \text{ mm}$.



NOTE!

Modules with a recent production date have two fixing knobs on the right side of the case and on the left two round holes (for greater torsional strength of the entire module assembly). If a module with fixing knobs is to be inserted into an existing module assembly and the adjacent module does not have the corresponding holes, the fixing knobs must be completely removed to ensure electrical contact between the modules. For example, a cutter knife and a file can be used for removal.

3.2.1 Input/output modules

In a sequence at the user's discretion, input/output modules can be arranged to the right next to a base unit or a router module.

Installation, using the example of a multichannel controller module 705010

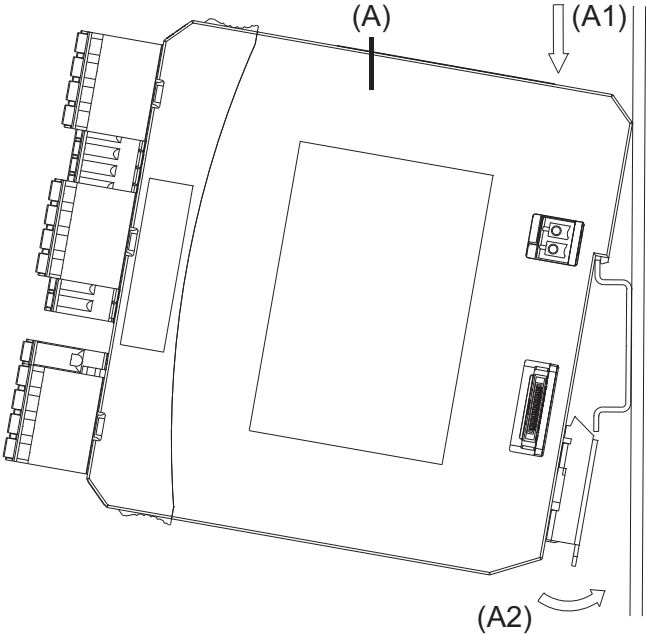

Example installation

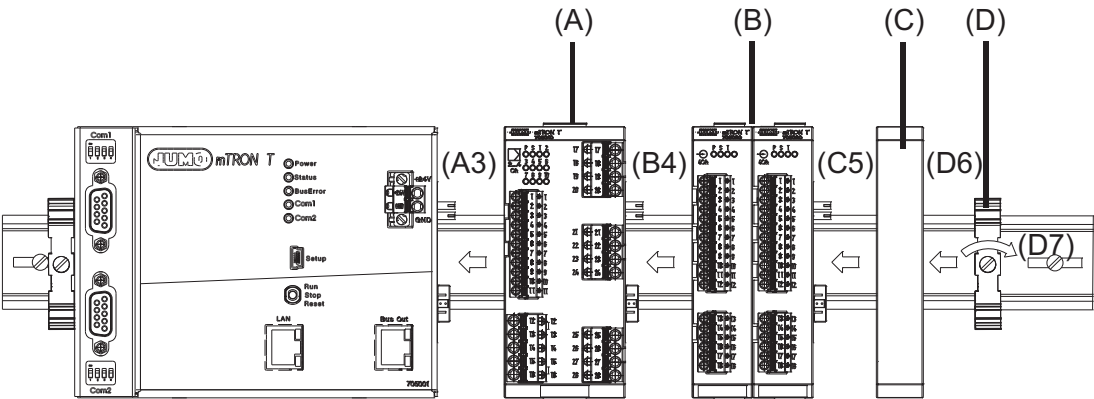

3 Installation

Procedure:

Step	Activity
1	Mount the multichannel controller module (A) in the DIN rail from above (A1).
2	Pivot the multichannel controller module (A) downward until it snaps into place (A2).
3	Move the multichannel controller module (A) to the left against the previous module (A3) until the plug connections for the voltage supply and the system bus are connected.
4	Position additional modules (B) and move to the left against the previous module (B4).
5	After the final module, position the cover (C) on the DIN rail and move to the left against the module (C5).
6	After attaching the cover, position the end bracket (D) on the DIN rail and move to the left against the cover (D6).
7	Fasten the end bracket (D) using a screwdriver (D7). For this purpose, ensure that the end bracket and the cover are positioned flush against the final module.

Dismounting, using the example of a multichannel controller module 705010

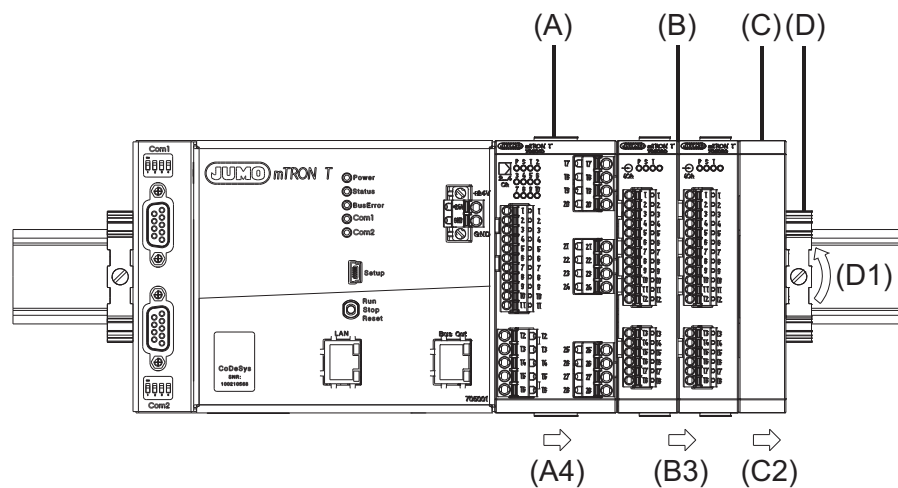

Removing the multichannel controller module from the DIN rail

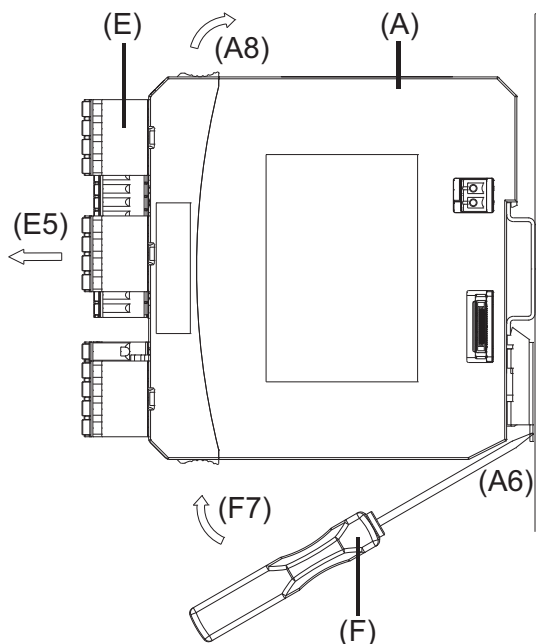

Procedure:

Step	Activity
1	<p>Fully release the end bracket (D) using a screwdriver (D1), press upward from below, pivot toward the front, and remove from the DIN rail.</p> <p>Note: The end bracket does not need to be removed from the DIN rail if there is sufficient space to the side to move it at least 20 mm to the right.</p>
2	<p>Move the cover (C) to the right (C2) until the side contacts of the neighboring module are exposed. Then release the cover at the bottom using a screwdriver, press upward, and remove from the DIN rail.</p> <p>Note: The cover does not need to be removed from the DIN rail if there is sufficient space to the side to move it at least 20 mm to the right.</p>
3	<p>Move the modules (B) on the right next to the multichannel controller module that is to be replaced (A) a minimum of 20 mm to the right (B3).</p> <p>➤ These modules are isolated from the voltage supply and the system bus.</p>
4	<p>Move the multichannel controller module (A) to the right (A4) until the side contacts of the neighboring module (here: central processing unit) – on the left, next to the multichannel controller module that is to be replaced – are exposed.</p> <p>➤ The multichannel controller module is isolated from the voltage supply and the system bus. This is a prerequisite for the dismounting of the multichannel controller module.</p>
5	<p>If required, pull off the wired terminals (E) of the multichannel controller module (A) toward the front (E5).</p>
6	<p>Insert a suitable screwdriver (F) into the unlocking slot of the multichannel controller module (A6) and press upward (F7).</p>
7	<p>Pivot the multichannel controller module (A) upward off the DIN rail (A8) and remove it.</p>

3 Installation

3.3 Replacing module inserts

3.3.1 Input/output modules



DANGER!

With multichannel controller module 705010 and relay module 705015, the load circuits from relay or solid state relay outputs can be operated with a dangerous electrical voltage (e.g. 230 V).

There is a risk of electric shock.

The load circuits are to be disconnected from the voltage supply prior to removing the wired terminal strips. This work must only be performed by qualified personnel.

Replacement of a module insert, using the example of a multichannel controller module 705010

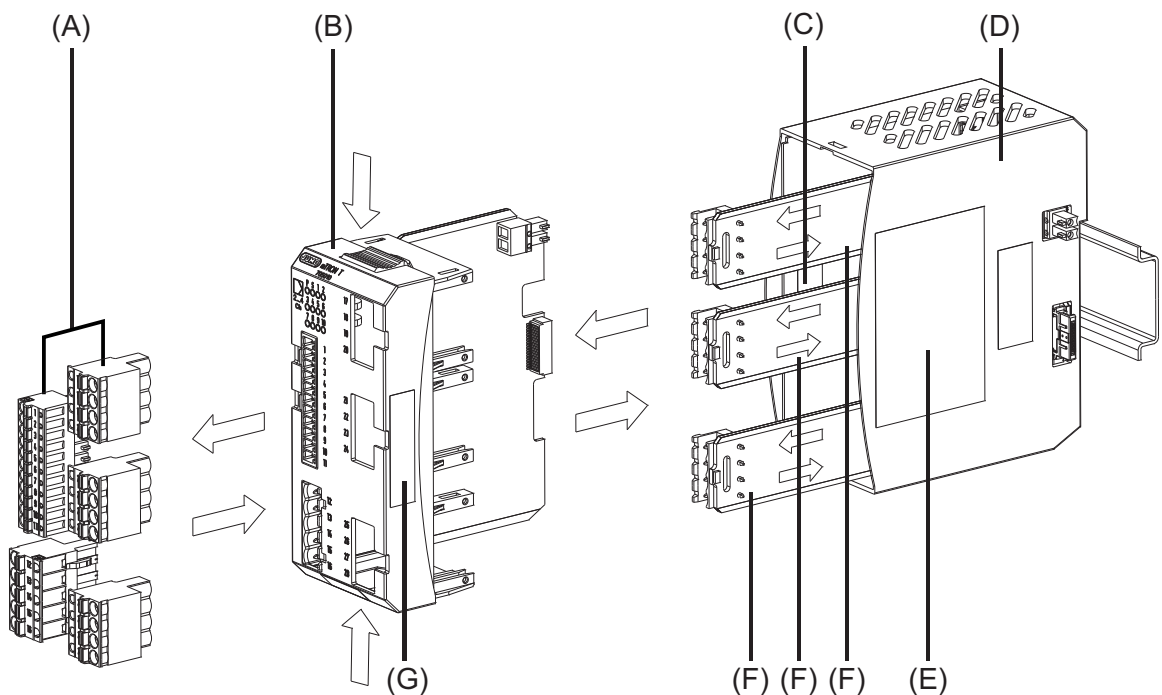

For service purposes (or when retrofitting options for the multichannel controller module), the case (D) can remain in the system; only the module insert (B) is replaced. For this purpose, the system does not need to be isolated from the voltage supply (hot swapping). If it is an optional module, the operation of the rest of the system (mandatory modules) is not interrupted. In the case of a mandatory module, the whole system goes into "Stop" system state (see setup program manual).

The system will detect a module insert of the same type that has been replaced and will automatically reconfigure it. Retrofitted functions for the multichannel controller module (expansion slots) must be configured using the setup program or the multifunction panel.

The new module insert also has a new nameplate (G), which will differ from the old one at least with regard to the fabrication number, and is no longer identical to nameplates (E) and (C) on the case (D).

Therefore, in the event of replacement, the module insert will be supplied along with a new nameplate that will be affixed to the case (D) in place of the old nameplate (C). This means that the specifications of nameplates (G) and (C) once again correspond to one another.



CAUTION!

Only module inserts of the same type may be used for the replacement. Otherwise, the function of the system may be affected. The module inserts can be clearly identified using the nameplate.



CAUTION!

With the multichannel controller module 705010, a new module insert may contain retrofitted inputs or outputs that have not yet been configured. This can lead to unintended behavior, particularly at the outputs and the actuators connected to them. Prior to using the retrofitted inputs or outputs, ensure that these have been configured correctly.

Removing the module insert

Step	Activity
1	Disconnect load circuits from the relay or solid state relay outputs.
2	Pull off the wired terminal strips (A) toward the front.
3	Press the old module insert (B) together on the grooved surfaces at the top and bottom and remove from the case (D).
4	For the multichannel controller module, also remove the modules (F) of the expansion slots from the case (D) toward the front, if required.

Mounting the module insert

Step	Activity
1	Affix the new nameplate in place of the old nameplate (C) in the case.
2	For the multichannel controller module, also insert the modules (F) of the expansion slots into the case (D), if required.
3	Hold the new module insert (B) at the grooved surfaces on the top and bottom and insert them into the case (D). For this purpose, ensure that the board of the module insert slides into the guide rails of the case. For the multichannel controller module, also ensure that the modules (F) of the expansion slots slide in the guide rails of the module insert.
4	Reattach the wired terminal strips (A).



NOTE!

When mounting the module insert, ensure that the snap holders (under the grooved surfaces) audibly snap into place.



NOTE!

The availability of the system can be increased through the storage of module inserts and modules for expansion slots.

3 Installation

3.4 Dimensions

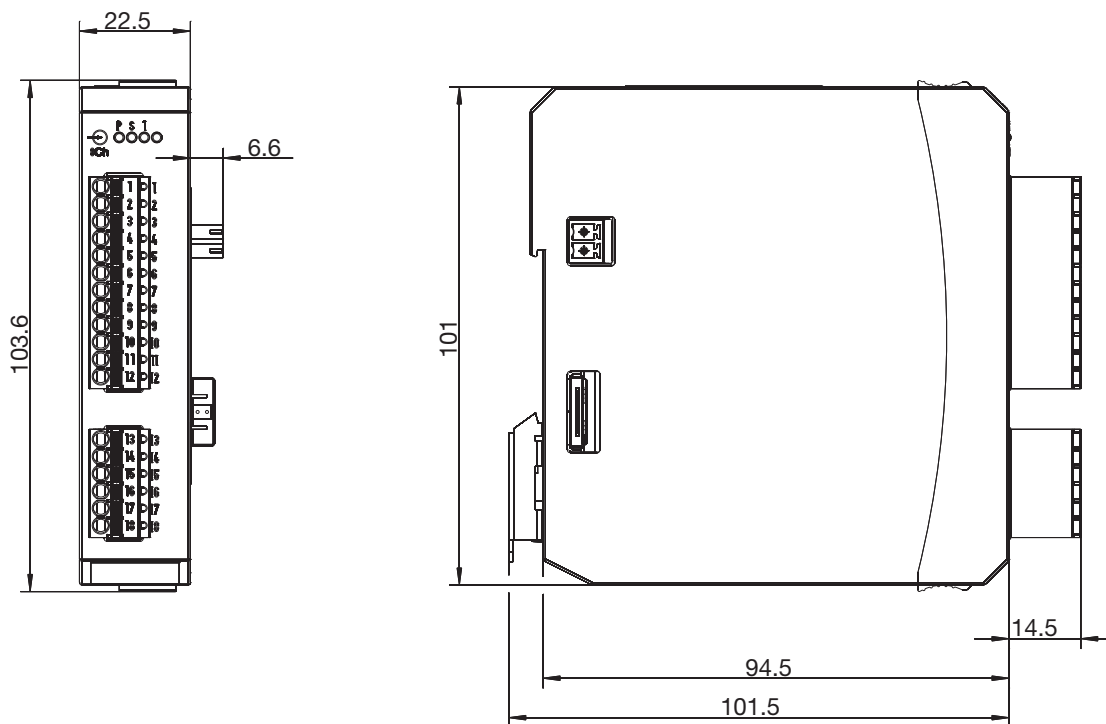

4.1 Installation notes

**NOTE!**

These installation notes apply for the entire measuring, control, and automation system and, on some occasions, are only applicable for a specific module.

The respective connection diagram shows the context.

Requirements for the personnel

- Work on the modules must only be carried out to the extent described and, like the electrical connection, only by qualified personnel.
- Before plugging and unplugging connection cables ensure that the person performing the work is electrostatically discharged (e.g. by touching grounded metallic parts).

Cables, shielding, and grounding

- When selecting the cable material, when installing, and when performing the electrical connection of the module, the regulations of DIN VDE 0100 "Erection of power installations with rated voltages up to 1000 V" and the respective national regulations (e.g. on the basis of IEC 60364) are to be observed.
- Certain cables must be heat resistant up to at least 80 °C at maximum load. The relevant instructions in the connection diagram of the affected modules must be observed.
- Route input, output, and supply cables separately and not parallel to one another.
- Only use shielded and twisted probe and interface cables. Do not route the lines close to current-carrying components or cables.
- For temperature probes, ground the shielding on one side in the control cabinet.
- Do not perform loophroughs on the grounding cables, but route the cables individually to a shared grounding point in the control cabinet; in doing so, ensure that the cables are as short as possible.
Ensure that the equipotential bonding is correct.

Electrical safety

- Isolate power supply units from the voltage supply on the primary side if there is a risk of touching parts with dangerous electrical voltage (e.g. 230 V) in the course of work.
- The fuse rating of the power supply units on the primary side should not exceed a value of 10 A (inert).
- With modules with relay or solid state relay outputs, the load circuits can be operated with a dangerous electrical voltage (e.g. 230 V). Disconnect load circuits from the voltage supply during installation/dismounting and electrical connection.
- In order to prevent the destruction of the relay or solid state relay outputs in the event of an external short circuit in the load circuit, the load circuit should be fused to the maximum admissible output current.
- The modules are not suitable for installation in areas with an explosion hazard.
- In addition to a faulty installation, incorrectly set values on the module could also impair the correct function of the following process. Therefore, ensure that safety devices independent of the module (e.g. overpressure valves or temperature limiters/monitors) are available and that it is only possible for qualified personnel to define settings. Please observe the corresponding safety regulations in this context.

4 Electrical connection

References to other information

- The electromagnetic compatibility meets the standards and regulations cited in the technical data.
- The USB device interface and voltage supply in the central processing unit 705001 are **not** electrically isolated. In general, please observe the specifications regarding electrical isolation.

4.2 Electrical isolation

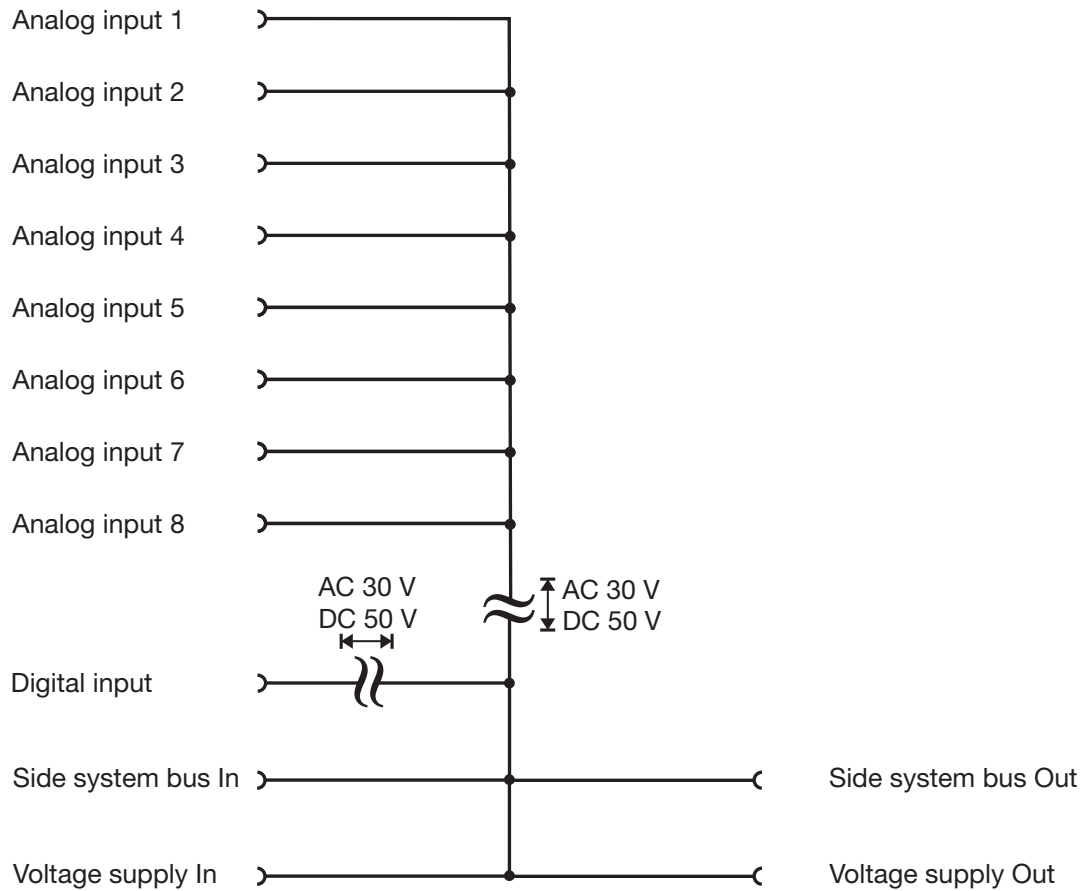

4.3 Connection diagram



CAUTION!

At maximum load, the temperature may exceed 60 °C at the terminals.
As a result the insulation of the cable may be damaged.
The cable must be heat resistant up to at least 80 °C.

4.3.1 Display and connection elements

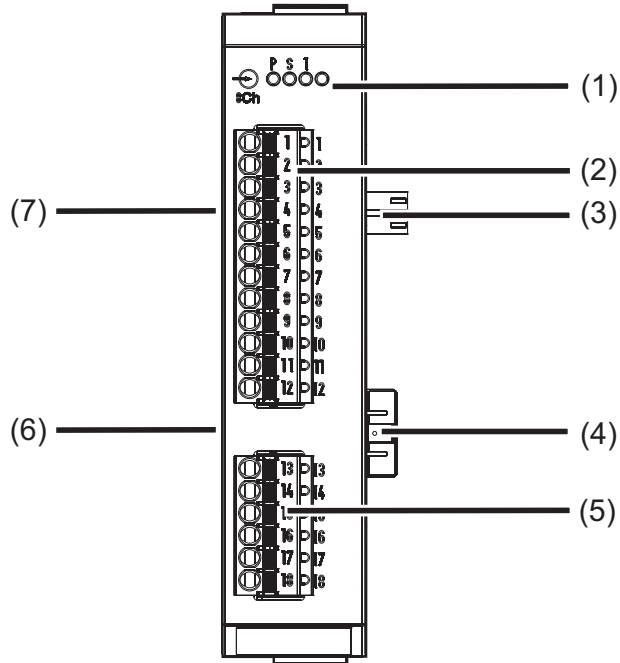

- (1) Status displays (LED)
 - P = Voltage supply
 - S = Status
 - 1 = Digital input
(LED is lit: Active)
- (2) Analog input 1 to 6
- (3) Voltage supply Out, DC 24 V
- (4) Side system bus Out
- (5) Analog input 7, 8;
digital input
- (6) Side system bus In
- (7) Voltage supply In, DC 24 V

4 Electrical connection

4.3.2 Analog inputs

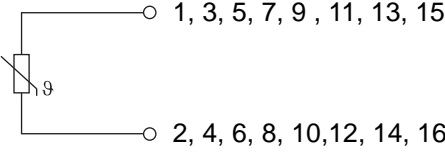
Connection	Input	Terminals	Symbol and terminal designation
RTD temperature probe 2-wire circuit	1	1 and 2	
	2	3 and 4	
	3	5 and 6	
	4	7 and 8	
	5	9 and 10	
	6	11 and 12	
	7	13 and 14	
	8	15 and 16	

4.3.3 Digital input

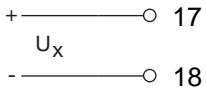
Connection	Input	Terminals	Symbol and terminal designation
Digital input DC 0/24 V	1	17 and 18	

4.4 Functional test

The **voltage supply** must be tested on completion of the electrical connection:

Signal	Meaning
LED "P" (Power, green) is lit	The module is being supplied with voltage through the side contacts.
LED "P" (Power, green) is not lit	<p>The module is not supplied with voltage or there is a problem with the electrical function of the LED.</p> <p>Remedy:</p> <ul style="list-style-type: none"> • Check the voltage supply to the side contacts of the preceding module (top contact +24 V, bottom contact GND). • Check voltage supply at the "+24 V" and "GND" terminals of the base unit or router module. • Check power supply unit and connection between the power supply unit and the base unit or router module. <p>If the "Power" LED does not light up despite a voltage supply being present, the module insert or – if the bus board inside the case is faulty – the entire module must be replaced.</p>

Startup

The check described above completes the process of installation and electrical connection. For startup, use the additional documentation (operating manual or system manual).

The "Introduction" section of this document contains an overview of all documentation for the measuring, control, and automation system.

5.1 Display and connection elements

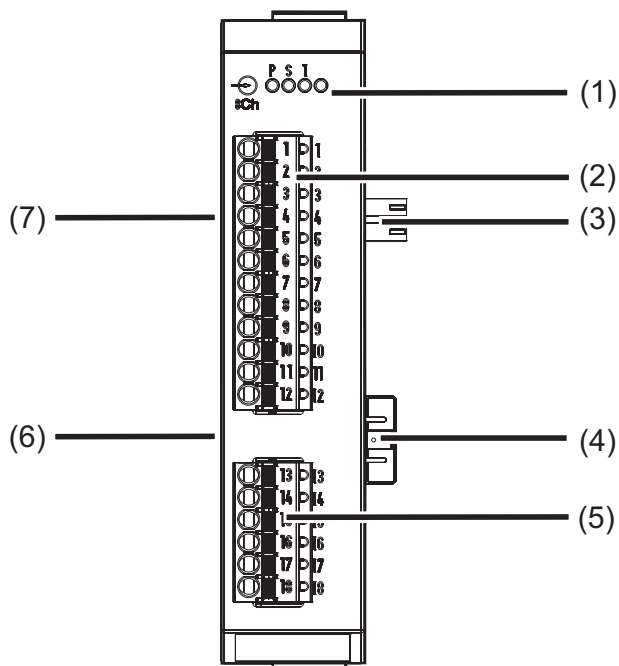

- (1) Status displays (LED)
 - P = Voltage supply
 - S = Status
 - I = Digital input
 - (LED is lit: Active)
- (2) Analog input 1 to 6
- (3) Voltage supply Out, DC 24 V
- (4) Side system bus Out
- (5) Analog input 7, 8;
digital input
- (6) Side system bus In
- (7) Voltage supply In, DC 24 V

5 Operation

5.2 LED displays

"P" LED (Power)

The LED is permanently lit in green if the module is being supplied with voltage.

"S" LED (Status)

This LED indicates the status of the module. Diagnostics requires the setup program or a Web browser as appropriate.

LED "1"

The LED indicates the status of the digital input.
LED lights up yellow = digital input is active

5.2.1 Display modes

The following table lists all possible states of the "S" LED (Status).

Display mode	Description	Green symbol	Red symbol
---	LED state not relevant	---	---
Off	LED off	○	○
On	LED on (permanently lit)	■	●
Flickering	LED flickers (50 ms on, 50 ms off)	■ ■ ■ ■	● ● ● ●
Single flickering	LED flashes briefly (50 ms on, 200 ms off)	■ □ □ □ □	● ○ ○ ○ ○
Blinking	LED flashes (200 ms on, 200 ms off)	■ □ ■ □ ■	● ○ ● ○ ●
Single flash	LED flashes once (200 ms on, 1000 ms off)	■ □ □	● ○ ○
Double flash	LED flashes twice (on/off/on for 200 ms each time, 1000 ms off)	■ ■ □ □	● ● ○ ○
Triple flash	LED flashes three times (on/off/on/off/on for 200 ms each time, 1000 ms off)	■ ■ ■ □ □	● ● ● ○ ○
Quadruple flash	LED flashes four times (on/off/on/off/on/off/on for 200 ms each time, 1000 ms off)	■ ■ ■ ■ □ □	● ● ● ● ○ ○
Blinking red/green	LED flashes red and green (200 ms red, 200 ms green)	● ■ ● ■	
On green/ Single flickering red	LED lights up green, flashes red (50 ms red)	■ ●	

5.2.2 System states and errors

The following table lists all the system states and errors that are indicated by the "S" LED (Status). In most cases, further diagnostics must be performed with the setup program.

Category	"S" LED (Status)	Meaning	Diagnostics with	Recommended action
Start error		Module error (hardware does not start up)	LED	Replace module
Start error		Internal error (bootloader) Various errors during startup (e.g. no memory, initialization error)	LED	Replace module
Start error		No firmware	LED	Replace module
Bus status		No connection to central processing unit	LED	Check whether the central processing unit is running; check cabling and topology
Bus status		System in "Stop" (INIT) state – no error, only in start phase	LED	
Bus status		System in "Stop" (PREOP) state – no error, only in start phase	LED	
Operation	 (Priority 1)	Module not calibrated (LED flashes red-green) or module in calibration mode (calibrate/test; LED flickers red-green)	LED/setup program	
Operation	 (Priority 2)	Collective alarm (incl. out of range)	LED/setup program	
Operation	 (Priority 3)	System in "Stop" (SAFEOP) state – no error	LED	
Operation	 (Priority 3)	System in "Run" (OP) state – no error	LED	

5 Operation



NOTE!

The parameters described in this section can be configured either with the setup program or on the multifunction panel.

6.1 Digital selector

The digital selector contains all digital signals that are available in the analog input module 8-channel to configure the following functions.

- Alarm suppression (see Chapter 6.2.1 "Alarms", page 36)
- Signal suppression (see Chapter 6.3 "Digital input", page 40)

The following table lists all digital signals. The entry in the "Type" column indicates the source of the signal:

- Internal: Internal signal of the analog input module 8-channel (including the signal of the digital input)The signal is also transmitted to the base unit via the system bus, to allow it to be used by other modules.
- External: External input (NV_...) that must be linked in the NV connecting list to a signal from another module (see Chapter 6.4 "NV connecting list", page 42).
The signal name "NV_..." indicates the intended use; in principle, the signal can also be used for other purposes.

Category	Signal	Type	Description
Inactive			No signal selected
Analog inputs	AI01Alarm1 to AI08Alarm1	Internal	Alarm signal 1 of analog input 1 to 8
	AI01Alarm2 to AI08Alarm2	Internal	Alarm signal 2 of analog input 1 to 8
Digital inputs	DI01	Internal	Signal of digital input
Signal rejections	NV_SR01 to NV_SR09	External	Signal for activating signal suppression
Alarm 	CollectiveAlarm	Internal	Module collective alarm

Alarm

The collective alarm of the analog input module 8-channel is made up of all functions for which the "Collective alarm" alarm type has been activated.

6 Configuration

6.2 Analog inputs

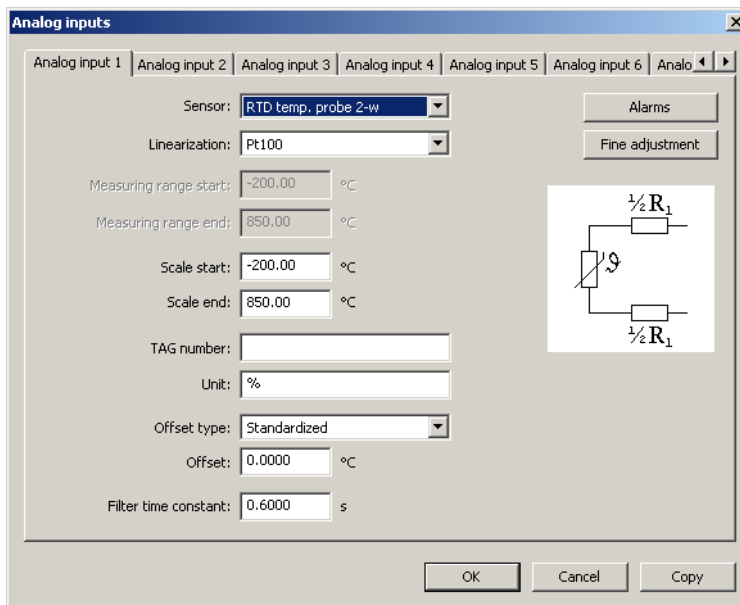

The eight analog inputs are measuring inputs for RTD temperature probes in 2-wire circuit.

Setup dialog



Parameter

Parameter	Selection/settings	Description
Sensor	Selection of measuring probe for the relevant analog input	
	No choice	No sensor selected
	RTD temp. probe 2-w	RTD temperature probe in 2-wire circuit
Linearization	Available options and factory settings depend on the measuring probe selected.	
	Linear	
	Pt100	DIN EN 60751
	Pt500	DIN EN 60751
	Pt1000	DIN EN 60751
	Pt100J	JIS 1604
Pt100G	GOST 6651-94	
Scale start	Factory setting depends on the linearization.	
	-99999 to +99999	Start value of display range
Scale end	Factory setting depends on the linearization.	
	-99999 to +99999	End value of display range
TAG number	7 characters (as of system version 05: 42 characters)	Identification marking (documentation in PLC)
Unit	5 characters (%)	Unit for numerical representation of measured value

Parameter	Selection/settings	Description
Offset type 	Type of measured value offset	
	Standardized	Offset of standardized measured value (after linearization)
	Physical	Offset of physical measured value (before linearization)
Offset 	-100 to 0 to +100 As of system version 04: -99999 to 0 to +99999	Correction value
Filter time constant 	0 s to 0.6 s to 100 s	Time constant for adjusting the digital input filter (0 s = filter off)

Offset type

To offset plant-specific deviations, the measured value can be offset for each analog input. When doing this, the offset type is used to specify the type of measured value offset.

"Standardized" offset type: The measured value is offset after linearization (temperature value in °C or °F).

"Physical" offset type: The physical measured value is offset before linearization (resistance in ohms).

A typical application scenario for the "physical" offset type is compensation of the lead wire resistance when using an RTD temperature probe.

Offset

A positive or negative form of the correction value is added to the measured value (entering a negative correction value reduces the measured value).

Filter time constant

The filter time constant is used to adjust the digital input filter (2nd order filter). If the input signal changes suddenly, approx. 26 % of the change is recorded following a period that corresponds to the filter time constant (2 × filter time constants: approx. 59 %; 5 × filter time constants: approx. 96 %). A large filter time constant means a high level of attenuation of interference signals, a slow reaction time of the actual value display, and low limit frequency (low-pass filter).

Status after change of configuration

The input values before the change of configuration are not saved; the new input values are available approx. 2 seconds after the change of configuration.

Behavior after power on

All analog inputs are initialized and start their measurements over (no statuses are saved with power off).

6 Configuration



6.2.1 Alarms

Limit value monitoring with one or two alarms and various alarm types can be activated for each analog input. In addition, this function is required in order to trigger the collective alarm of the module if the event of deviation above or below the measuring range (out of range).

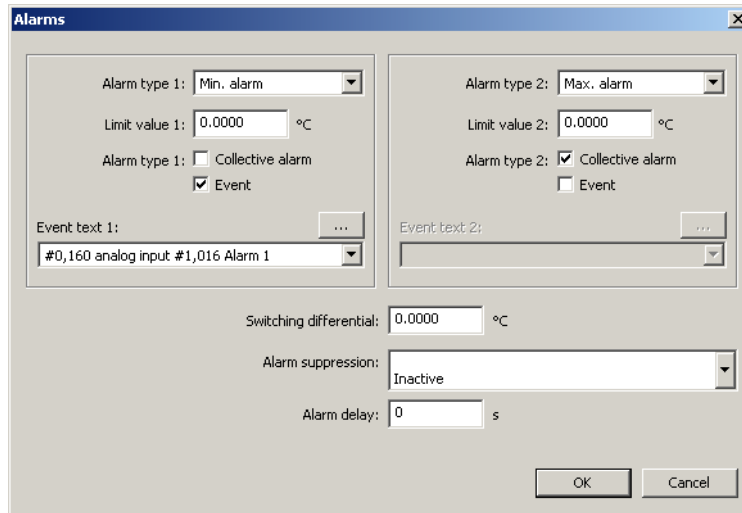
Setup dialog



Parameter

Parameter	Selection/settings	Description
Alarm type 1, 2 	Off Min. alarm Max. alarm	Monitoring is not active. Alarm is issued if the limit value is not met. Alarm is issued if the limit value is exceeded.
Limit value 1, 2	-99999 to 0 to +99999	Limit value at which an alarm is issued.
Kind of alarm 1, 2	The alarm type is not set by default.	
	Collective alarm	Alarm results in collective alarm of the module.
	Event	Alarm results in an entry (event text) in the event list.
Event text 1, 2 	Use default text or select other text from the list.	Text that is entered in the event list for an alarm (if Alarm type = "Event").
Switching differential 	0 to 99999	Used to suppress constant switching operations in the event of minor fluctuations of the input signal around the limit value.
Alarm suppression	Digital selector (Inactive) ⇒ Chapter 6.1 "Digital selector", page 33	Signal to activate the alarm suppression
Alarm delay	0 s to 65535 s	Delay time for alarm activation

Alarm type and switching differential

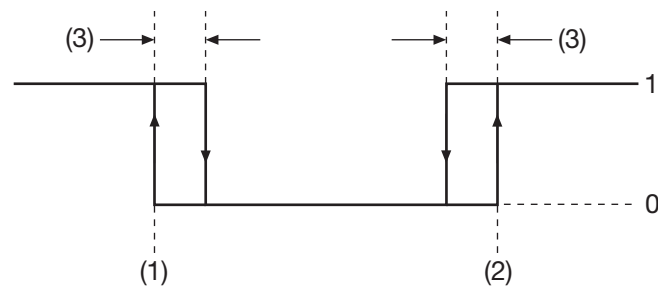

- (1) Min. alarm/limit value
- (2) Max. alarm/limit value
- (3) Switching differential

- 1 Alarm on
- 0 Alarm off

Event text

Setup program: Selection of text from a list

Click the "... " button to open a list with the text numbers and the associated texts. The texts can be edited.

Multifunction panel: Selection of text using the text number

The setup program is required to view and edit the texts.

Collective alarm for out of range

In the event of deviation above or below the measuring range (out of range, O-o-R) or in the event of a probe/conductor break or probe/conductor short-circuit, the collective alarm of the module can also be triggered. To do this, you must activate at least one alarm type and select the "Collective alarm" alarm type.

If the alarm type is only being activated for this purpose, the measuring range start (for Min. alarm) or measuring range end (for Max. alarm) must be entered as a limit value. Otherwise, in the event of deviation above or below the value – for example if the default value 0 is retained – this also results in a module collective alarm.

The collective alarm of the module is entered in the event list of the central processing unit, which enables you to identify the affected module. If there is also a need to identify the affected analog input, you must also activate the "Event" alarm type and select an appropriate event text.

6 Configuration

6.2.2 Fine adjustment

You can use customer-specific fine adjustment to correct the measured values of the analog input. In contrast to offsetting, which is used to specify a constant correction value for the entire characteristic line, fine adjustment can also be used to change the gradient of the characteristic line.

Setup dialog

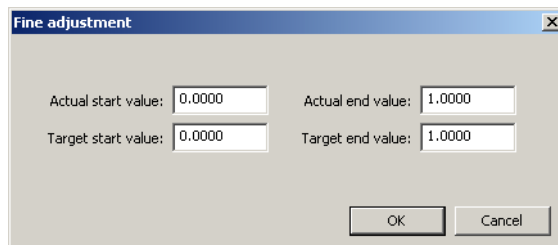

Parameter

Parameter	Selection/settings	Description
Actual start value	-99999 to 0 to +99999	Lower display value
Target start value	-99999 to 0 to +99999	Lower reference value
Actual end value	-99999 to 1 to +99999	Upper display value
Target end value	-99999 to 1 to +99999	Upper reference value

Example

The temperature inside a furnace is measured with an RTD temperature probe and displayed. Due to the temperature drift of the sensor, the true temperature (reference measurement) deviates from the displayed value. The amount of deviation is different at the upper and lower measuring points, meaning that measured value offset is not suitable.

Actual start value: 15 °C (displayed value)

Target start value: 20 °C (reference measurement)

Actual end value: 70°C (displayed value)

Target end value: 80 °C (reference measurement)

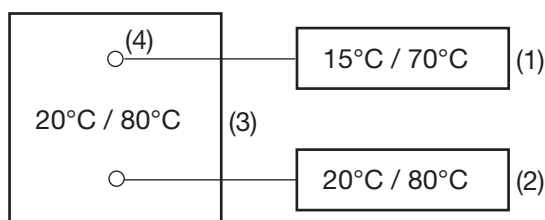

(1) Display value

(3) Furnace

(2) Reference value

(4) Sensor in RTD temperature probe

Performing fine adjustment

- 1) Determine the lower value (as low and constant as possible) with the reference measuring device.
Example: Set furnace temperature to 20 °C.
- 2) Enter the display value as the actual start value and the reference value as the target start value.
Example: Enter 15 and 20.
- 3) Determine the upper value (as high and constant as possible) with the reference measuring device.
Example: Increase furnace temperature to 80 °C.
- 4) Enter the display value as the actual end value and the reference value as the target end value.
Example: Enter 70 and 80.

Characteristic line

The following diagram shows the changes in the characteristic line caused by the fine adjustment (point of intersection with the x axis as well as the gradient).

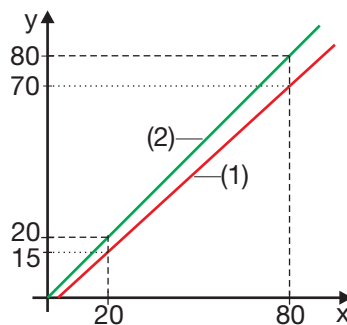

y	Display value	(1)	Characteristic line before fine adjustment
x	Reference value	(2)	Characteristic line after fine adjustment

Resetting the fine adjustment

The following settings must be made to reverse the fine adjustment:

Actual start value = target start value

Actual end value = target end value

6 Configuration

6.3 Digital input

In addition to the analog inputs the module provides a digital input.

The status of the digital input is indicated by a LED. The display corresponds to the output signal to the system bus.

Setup dialog

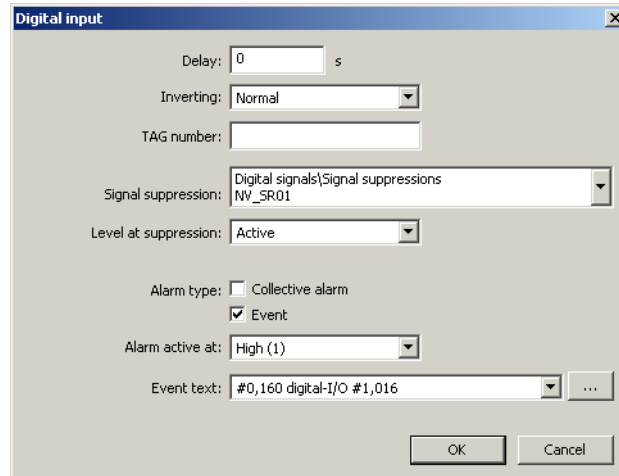

Parameter

Parameter	Selection/settings	Description
Mode: Delay	0 s to 65535 s	Delay time during change of input signal from Low to High (or from High to Low in the case of active inverting)
Inverting	Inversion of the input signal Normal Inverse	Not inverted Inverted
TAG number	7 characters (as of system version 05: 42 characters)	Identification marking (documentation in PLC)
Signal suppression 	Digital selector (Inactive) ⇒ Chapter 6.1 "Digital selector", page 33	Signal (high-active) for suppression of the input signal
Level at suppression	Output level during active signal suppression No choice Active	Low level (0) High level (1)
Alarm type	The alarm type is not set by default. Collective alarm Event	Alarm results in collective alarm of the module. Alarm results in an entry (event text) in the event list.
Alarm active at	High (1) Low (0)	Alarm at high level (1) Alarm at low level (0)

Parameter	Selection/settings	Description
Event text 	Use default text or select other text from the list.	Text that is entered in the event list for an alarm (if Alarm type = "Event").

Signal suppression

When signal suppression is active, the input signal and the inverting and delay parameters are irrelevant. In this case, a fixed signal with a configurable level is issued (to the system bus).

Event text

Setup program: Selection of text from a list

Click the "..." button to open a list with the text numbers and the associated texts. The texts can be edited.

Multifunction panel: Selection of text using the text number

The setup program is required to view and edit the texts.

Status after change of configuration

The output signal to the system bus always adopts the status that corresponds to the current configuration.

Behavior after power on

After initialization, the input signals are available immediately, according to their configuration.

6 Configuration

6.4 NV connecting list

The NV connecting list is used to link external inputs (NV_...) of the analog input module 8-channel to signals from other modules via the system bus.

A comprehensive list with the module signals is included in the following chapter.

⇒ Chapter 6.4.1 "Digital signals (overview)", page 44

Further information about the signals can be found in the operating manual for the relevant module.

Replacement values are available in the event that these signals are not available (connection to base unit interrupted in "Stop" state).

⇒ Chapter 6.4.2 "Replacement values (overview)", page 50



NOTE!

There is no NV connecting list in the input/output module configuration menu on the multi-function panel. Instead, a central NV connecting list is available in the configuration menu of the base unit (CPU).

Setup dialog

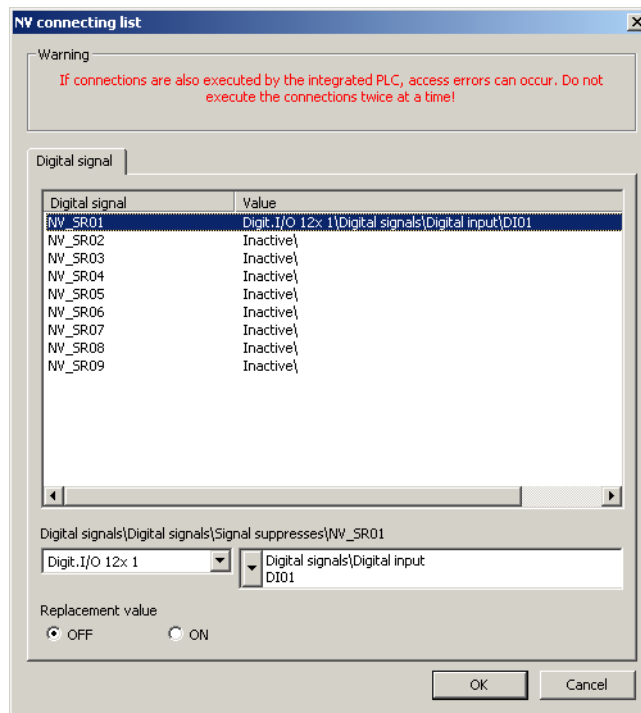

Parameter

Parameter	Selection/settings	Description
Digital signal / Value	Select input to be connected.	List of external inputs of the module If a connection has already been configured, the module and its signal are displayed in the "Value" column.

Parameter	Selection/settings	Description
...\NV_SR01 (Example)	This is the previously selected external input.	
	Select the module and – in the selector next to it on the right – the signal to connect to the external input.	List of modules in the system and the relevant signals
Replacement value 	Replacement value for the relevant signal (The selection On/Off is active if a signal is assigned to the external input.)	
	Off	Low level (0)
	On	High level (1)

Replacement value

The replacement value is used if the relevant signal is not available (connection to base unit interrupted or system in "Stop" state).

Status after change of configuration

The connections are available immediately.

Behavior after power on

The connections are available immediately after system initialization.

6 Configuration

6.4.1 Digital signals (overview)

The following table contains all signals that are available in the NV connecting list for connection to the external inputs (NV_....) of the analog input module 8-channel.

Category	Signal	Description
Inactive		No signal selected
Central processing unit		
Digital variables	Digital variable 1 to 64	Digital variable 1 to 64 (via interface)
Program generator 1 to Program generator 9	Operating contact 1 to 16	Operating contact 1 to 16 of program channels (in the three program channels, operating contacts with the same name are linked with OR)
	Mode: Basic status	Status: Program is not running (basic status)
	Mode: Automatic	Status: Program is running (automatic mode, no delay time or program end time)
	Mode: Automatic 1	Status: Program is running (automatic mode, incl. delay time and program end time)
	Mode: Standstill	Status: Program stopped during automatic mode (time base stopped)
	Mode: Delay	Status: Program start delayed (delay time runs)
	Mode: Program end	Status: Program ends (program end time runs, corresponds to length of end signal)
	Mode: Manual	Status: Manual mode
	Tolerance band channel 1 to 3	Tolerance band signal of program channel 1 to 3
	Batch control	Signal to control the batch recording (OR-linked signals "Automatic", "Standstill", and "Program end").
	PLC Binary output 28 to 32	Signal of PLC digital output 28 to 32
Limit monitoring	Limit monitoring 1 to 64	Output signal of limit value monitoring 1 to 64
Binary linking	Binary linking 1 to 8	Result of binary linking 1 to 8
	PLC Binary output 9 to 32	Signal of PLC digital output 9 to 32
Binary PLC output block 13 to block 18	PLC Binary output 1 to 32	Signal of PLC digital output 1 to 32

6 Configuration

Category	Signal	Description
Alarm analog variables	Alarm1 ExAI1 to Alarm1 ExAI64	Alarm signal 1 of analog variable 1 to 64
	Alarm2 ExAI1 to Alarm2ExAI64	Alarm signal 2 of analog variable 1 to 64
Alarm integer variables	Alarm1 ExInt1 to Alarm1 ExInt64	Alarm signal 1 of integer variable 1 to 64
	Alarm2 ExInt1 to Alarm2ExInt64	Alarm signal 2 of integer variable 1 to 64

6 Configuration

Category	Signal	Description
Alarms/ Faults	CAlarm/Fault	System collective alarm or system fault (central processing unit and modules)
	CAlarm/Fault ackn.	System collective alarm or system fault with acknowledgement Signal remains active until acknowledgement.
	CAlarm device	System collective alarm (central processing unit and modules)
	CAlarm ackn.	System collective alarm with acknowledgement Signal remains active until acknowledgement.
	Fault	System fault (central processing unit and modules)
	Fault ackn.	System fault with acknowledgement Signal remains active until acknowledgement.
	CAlarm Basis	Central processing unit collective alarm
	System Run	System state (Run = 1, Stop = 0)
	Reserve 1	(Reserved for future use.)
	Fieldbus error	Error at fieldbus interface
	System error mandatory	Error in a mandatory module
	System error optional	Error in an optional module
	No PLC	No PLC program available
	PLC stop	„Stop“ system state
	Battery empty	Battery alarm (central processing unit buffer battery is dead and must be replaced) Notify service department! Attention: RAM memory content is deleted!
Battery low	Battery pre-warning (central processing unit buffer battery can be replaced within 4 weeks without data loss) Notify service department!	

6 Configuration

Category	Signal	Description
Multichannel controller module		
Controller	C01ManualMode to C04ManualMode	Manual mode active for controller channel 1 to 4
	C01TuneActive to C04TuneActive	Self-optimization active for controller module 1 to 4
	C01Output1 to C04Output1	Switch position of first controller output of controller channel 1 to 4
	C01Output2 to C04Output2	Switch position of second controller output of controller channel 1 to 4
	C01CollAlarm to C04CollAlarm	Collective alarm of controller channel 1 to 4 (can be configured with signals from the digital selector)
Setpoint	SP01RampTolBand to SP04RampTolBand	Alarm signal of tolerance band monitoring of ramp function 1 to 4
	SP01Changeover1 to SP04Changeover1	Bit 0 of setpoint changeover of setpoint value function 1 to 4
	SP01Changeover2 to SP04Changeover2	Bit 1 of setpoint changeover of setpoint value function 1 to 4
Analog inputs	AI01Alarm1 to AI04Alarm1	Alarm signal 1 of analog input 1 to 4
	AI01Alarm2 to AI04Alarm2	Alarm signal 2 of analog input 1 to 4
Digital inputs	DI01, DI02, DI05 to DI10	Signal of digital input 1, 2, 5 to 10 If the HW counter is activated, the signal of digital input 1 is inactive.
Limit monitoring	LI01 to LI04	Output signal of limit value monitoring 1 to 4
Mathematics	Logic01 to Logic04	Result of logic function 1 to 4
Miscellaneous	CollectiveAlarm	Controller module collective alarm
	HWCounterSignal	Signal of hardware counter in "fill" operating mode (as shut-down signal when threshold value reached)

6 Configuration

Category	Signal	Description
Analog input module 4-channel		
Analog inputs	AI01Alarm1 to AI04Alarm1	Alarm signal 1 of analog input 1 to 4
	AI01Alarm2 to AI04Alarm2	Alarm signal 2 of analog input 1 to 4
Digital inputs	DI01	Signal of digital input
Alarm	CollectiveAlarm	Module collective alarm
Analog input module 8-channel		
Analog inputs	AI01Alarm1 to AI08Alarm1	Alarm signal 1 of analog input 1 to 8
	AI01Alarm2 to AI08Alarm2	Alarm signal 2 of analog input 1 to 8
Digital inputs	DI01	Signal of digital input
Alarm	CollectiveAlarm	Module collective alarm
Digital input/output module 12-channel		
Digital inputs	DI01 to DI12	Signal of digital input 1 to 12
Alarm	CollectiveAlarm	Module collective alarm
Multifunction panel 840		
System bus digital inputs	Alarm batch 1 to Alarm batch 9	Collective alarm of batch 1 to 9 (process values)
	CollectiveAlarm	Collective alarm of multifunction panel (process values)
	Fault	Fault in multifunction panel (independent of process values)
	Batch 1 active to Batch 9 active	Signal for active batch 1 to 9
	Push button 1 to Push button 18 (as of system version 02: 1 to 32)	Status of push button 1 to 18 (as of system version 02: 1 to 32) in process screen

6 Configuration

Category	Signal	Description
Thyristor power controller, type 70906x		
Device status	Individual digital signals of the power controller: See operating manual 70500153T90... (or following table)	Device status signals
Faults master		Faults of the power controller in single-phase operation or of the master in case of three-phase economy circuit or three-phase circuit
Faults slave/ slave1		Faults of the slave in case of three-phase economy circuit or of slave 1 in case of three-phase circuit
Faults slave2		Faults of slave 2 in case of three-phase circuit
Faults master slave		Faults of master slave connection and communication
Hardware input/ output		Binary values of hardware inputs and outputs

6 Configuration

6.4.2 Replacement values (overview)

The following table contains the replacement values with their factory settings. Replacement values can only be configured in the setup program.

Digital signals

Category	Signal	Factory setting	Description
Signal suppression	NV_SR01 to NV_SR09	Off	Signal for activating signal suppression



NOTE!

An active connection between the setup program and the central processing unit is required to configure the parameters described in this section.

7.1 Calibrate / test

7.1.1 Analog input



CAUTION!

Incorrect settings may result in inadmissible changes to values. This can have negative effects on the system function. Individual functions must be changed only by (or under the instruction of) a service technician of the device manufacturer.

Setup dialog

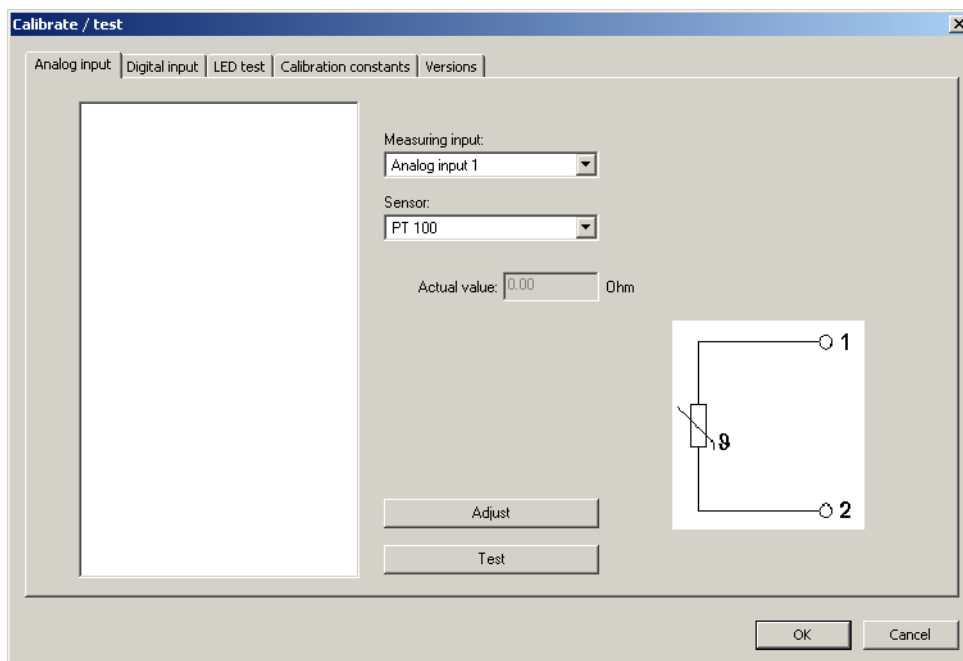

Parameter

Parameter	Selection/settings	Description
Measuring input	Select input (drop-down list).	Input on which the calibration or test is to be performed.
Sensor	Select sensor (drop-down list).	Sensor type that is connected at the relevant input.
Actual value	None	Display of the actual value read out
Test 	Click the "Test" button.	An additional window opens with instructions for testing (see below).

7 Online parameters

Test



The results of the test measurement are shown in the display field.

7.1.2 Digital input

Setup dialog

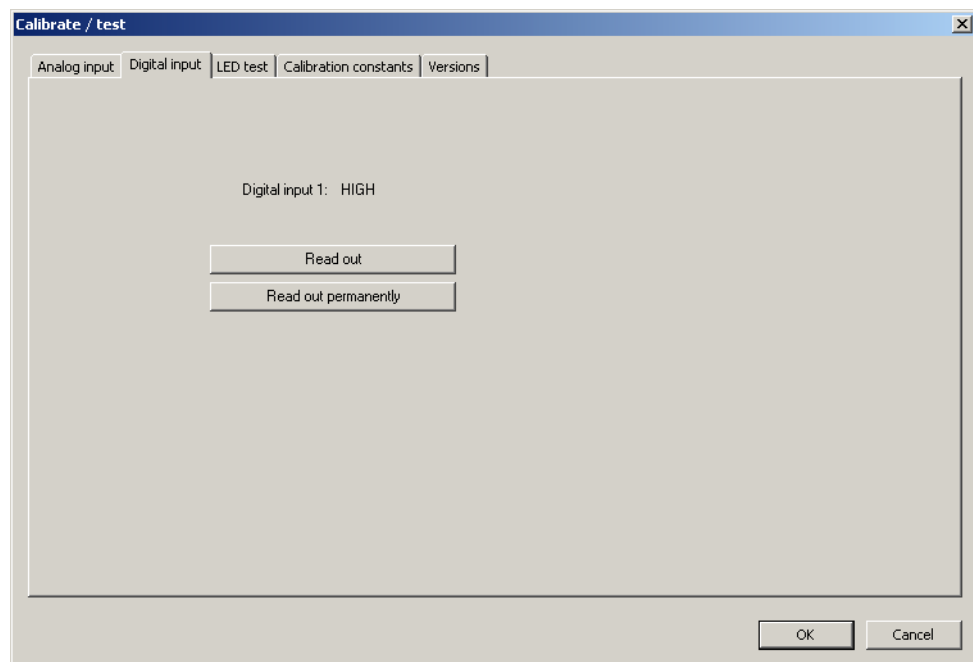

Parameter

Parameter	Selection/settings	Description
Read out	Click the "Read out" button.	The input is read out and the result is displayed (LOW, HIGH).

7.1.3 LED test

Setup dialog

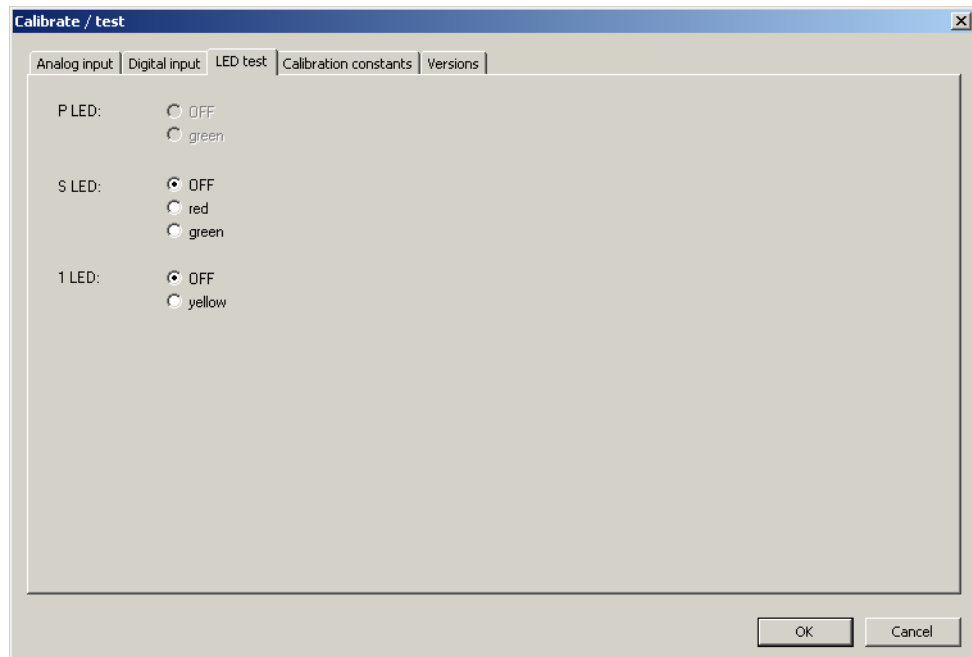

Parameter

Parameter	Selection/settings	Description
S LED	To test the LED, click the required status to select it (OFF, red, or green). After selection, the LED enters the chosen status immediately.	This function is used to test the electrical function of the "S" LED (Status).
1 LED	To test the LED, click the required status (OFF or yellow) to select it. After selection, the LED enters the chosen status immediately.	This function is used to test the electrical function of LED "1".



NOTE!

An LED maintains the set status until a new status is set or until the "LED test" dialog window is closed.

7 Online parameters

7.1.4 Calibration constants

Setup dialog

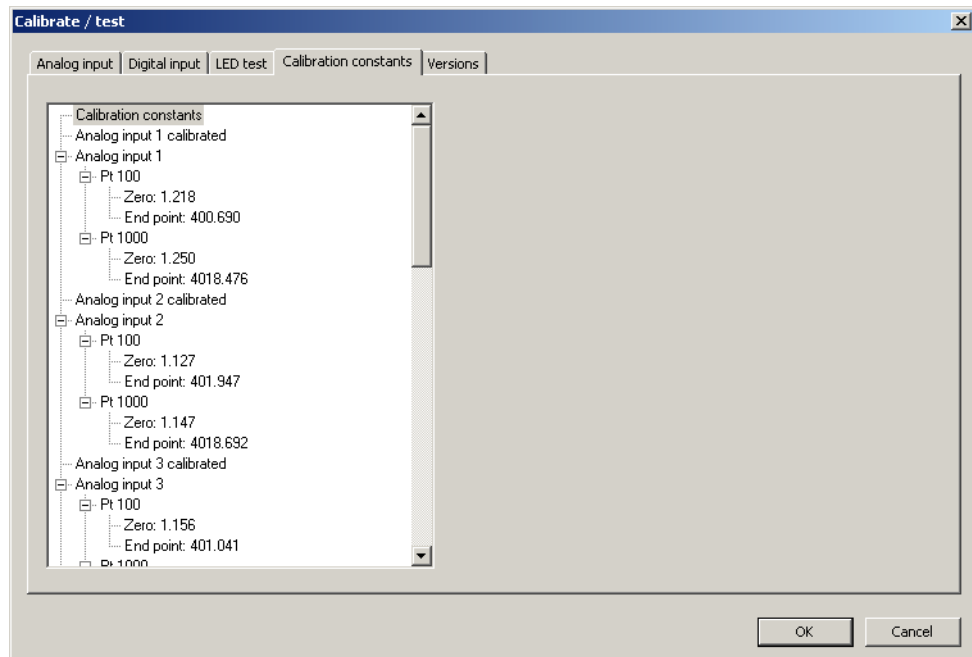

This dialog displays the calibration status and the calibration constants of the analog inputs.

7.1.5 Versions

Setup dialog

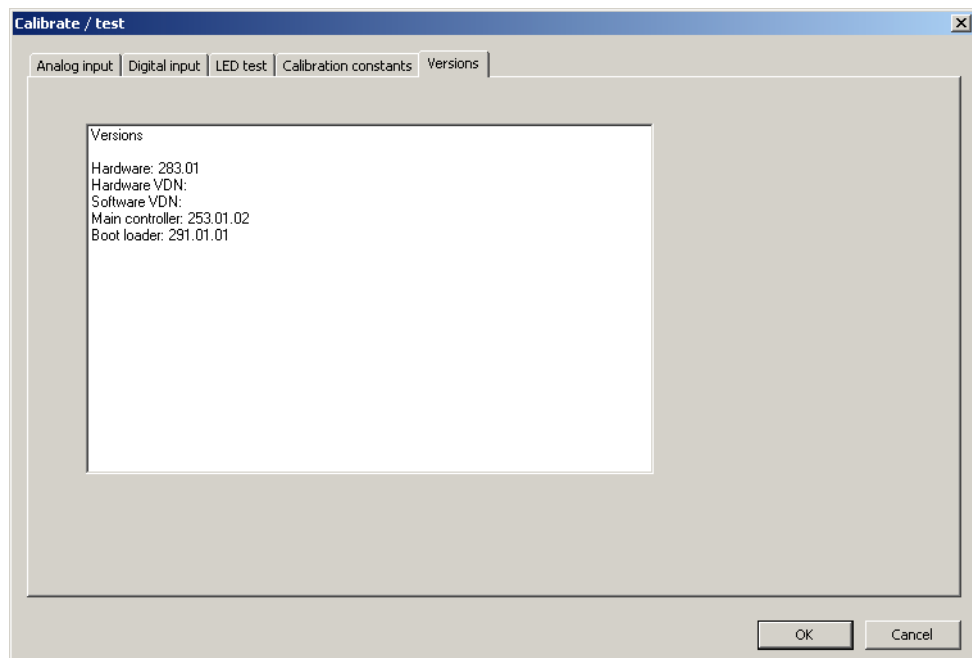

This dialog displays the module versions.

8.1 Technical data

8.1.1 Analog inputs

General information

Number	8
A/D converter	Resolution 16 bit

RTD temperature probe

Designation	Standard	Measuring range	Measuring accuracy ¹	Ambient temperature influence
Pt100 2-wire circuit	DIN EN 60751	-200 to +850 °C	≤ 0.08 %	50 ppm/K
Pt500 2-wire circuit	DIN EN 60751	-200 to +850 °C	≤ 0.08 %	50 ppm/K
Pt1000 2-wire circuit	DIN EN 60751	-200 to +850 °C	≤ 0.08 %	50 ppm/K
Pt100 2-wire circuit	JIS 1604	-200 to +650 °C	≤ 0.08 %	50 ppm/K
Pt100 2-wire circuit	GOST 6651-94	-200 to +850 °C	≤ 0.08 %	50 ppm/K
Measuring current	Pt100 approx. 380 µA, Pt 500, and Pt1000 approx. 150 µA; not constant			
Lead compensation	A lead resistance can be compensated in the software by correcting the process value.			

¹ The accuracy values refer to the maximum measuring range. Smaller measuring ranges lead to reduced linearization accuracy.

Measuring circuit monitoring

In the event of an error the digitized output values move to a defined status.

Measuring element	Out of range	Probe/cable short circuit	Probe/cable break
RTD temperature probe	Is detected	Is detected	Is detected

8.1.2 Digital input

Number	1
Input signal	DC 0/24 V (PLC level; logical "0" = -3 to +5 V; logical "1" = +15 to +30 V)

8 Appendix

8.1.3 Electrical data

Voltage supply Connection Voltage Residual ripple	Lateral (feed via base unit or router module) DC 24 V +25/-20 % 5 %
Current consumption	80 mA (at DC 19.2 V)
Power consumption	2 W
Inputs (terminals 1 to 18) Connection	At the front (removable terminal strips with Push-In technology)
Conductor cross section on terminals 1 to 18 Wire or strand without ferrule Strand with ferrule	Min. 0.14 mm ² , max. 1.5 mm ² Without plastic collar: Min. 0.25 mm ² , max. 1.5 mm ² With plastic collar: Min. 0.25 mm ² , max. 0.5 mm ²
Stripping length on terminals 1 to 18	9 mm
Electrical safety	Acc. to DIN EN 61010-1 Overvoltage category III, pollution degree 2
Electromagnetic compatibility Interference emission Interference immunity	Acc. to DIN EN 61326-1 Class A – only for industrial use – Industrial requirements

8.1.4 Case and ambient conditions

Case type	Plastic case for DIN rail mounting in the control cabinet (indoor use); DIN rail acc. to DIN EN 60715, 35 mm x 7.5 mm x 1 mm
Dimensions (W x H x D)	22.5 mm x 103.6 mm x 101.5 mm (without connection elements)
Weight	Approx. 125 g
Protection type	IP20, acc. to DIN EN 60529
Ambient temperature range	-20 to +55 °C
Storage temperature range	-40 to +70 °C
Resistance to climatic conditions	Relative humidity ≤ 90 % annual average without condensation (climatic class 3K3 acc. to DIN EN 60721-3-3 with extended temperature and humidity range)
Site altitude	Up to 2000 m above sea level
Mechanical ambient conditions ¹	Classification acc. to DIN EN 60721-3-3, table 6, class 3M2

¹ Test conditions are listed in the System Description B 705000.8.

8.1.5 Approval/approval marks

Approval mark	Testing agency	Certificate/certification number	Inspection basis	Valid for
c UL us	Underwriters Laboratories	E201387	UL 61010-1 (3. Ed.), CAN/CSA-22.2 No. 61010-1 (3. Ed.)	all types
DNV GL	DNV GL	TAA000016N	Class Guideline DNVGL-CG-0339	all types; a power supply unit with DNV GL or GL type approval is required (e.g. type 705090)

8 Appendix

8.2 China RoHS

 产品组别 Product group: 705021 部件名称 Component Name	产品中有害物质的名称及含量 China EEP Hazardous Substances Information					
	铅 (Pb)	汞 (Hg)	镉 (Cd)	六价铬 (Cr(VI))	多溴联苯 (PBB)	多溴二苯醚 (PBDE)
外壳 Housing (Gehäuse)	○	○	○	○	○	○
过程连接 Process connection (Prozessanschluss)	○	○	○	○	○	○
螺母 Nuts (Mutter)	○	○	○	○	○	○
螺栓 Screw (Schraube)	○	○	○	○	○	○

本表格依据SJ/T 11364的规定编制。
 This table is prepared in accordance with the provisions SJ/T 11364.
 ○：表示该有害物质在该部件所有均质材料中的含量均在GB/T 26572规定的限量要求以下。
 Indicate the hazardous substances in all homogeneous materials' for the part is below the limit of the GB/T 26572.
 x：表示该有害物质至少在该部件的某一均质材料中的含量超出GB/T 26572规定的限量要求。
 Indicate the hazardous substances in at least one homogeneous materials' of the part is exceeded the limit of the GB/T 26572.



JUMO GmbH & Co. KG

Street address:
Moritz-Juchheim-Straße 1
36039 Fulda, Germany

Delivery address:
Mackenrodtstraße 14
36039 Fulda, Germany

Postal address:
36035 Fulda, Germany

Phone: +49 661 6003-0
Fax: +49 661 6003-607
Email: mail@jumo.net
Internet: www.jumo.net

JUMO Instrument Co. Ltd.

JUMO House
Temple Bank, Riverway
Harlow, Essex, CM20 2DY, UK

Phone: +44 1279 63 55 33
Fax: +44 1279 62 50 29
Email: sales@jumo.co.uk
Internet: www.jumo.co.uk

JUMO Process Control, Inc.

6733 Myers Road
East Syracuse, NY 13057, USA

Phone: +1 315 437 5866
Fax: +1 315 437 5860
Email: info.us@jumo.net
Internet: www.jumousa.com

