

JUMO GmbH & Co. KG
 Delivery address: Mackenrodtstraße 14,
 36039 Fulda, Germany
 Postal address: 36035 Fulda, Germany
 Phone: +49 661 6003-0
 Fax: +49 661 6003-607
 e-mail: mail@jumo.net
 Internet: www.jumo.net

JUMO Instrument Co. Ltd.
 JUMO House
 Temple Bank, Riverway
 Harlow, Essex CM 20 2TT, UK
 Phone: +44 1279 635533
 Fax: +44 1279 635262
 e-mail: sales@jumo.co.uk
 Internet: www.jumo.co.uk

JUMO Process Control, Inc.
 8 Technology Boulevard
 Canastota, NY 13032, USA
 Phone: 315-697-JUMO
 1-800-554-JUMO
 Fax: 315-697-5867
 e-mail: info@jumo.us
 Internet: www.jumo.us



Analog input module

Brief description

The unit is a module of the JUMO mTRON control and automation system. The plastic housing measures 91 mm x 85.5 mm x 73.5 mm (W x H x D) and is mounted on a standard rail.

The module has four universal analog measurement inputs which can be monitored against adjustable limit values, one logic input, one counter input, one math function and a customized linearization which can be used for capturing and processing the measurement. There is also a selectable comparator function with switch-on and switch-off delay, as well as latching and gate circuit.

The analog input module incorporates a network connection for communication and data interchange between the modules. Numerous process and status signals can be exchanged with other units via the network.

A screened twisted pair is used as transmission line.

There is a setup interface for module parameter setting and configuration from a PC under the JUMO mTRON-iTOOL project design software.

The electrical connections are made through plug-in connectors with screw terminals.



Type 704020/...

Block structure

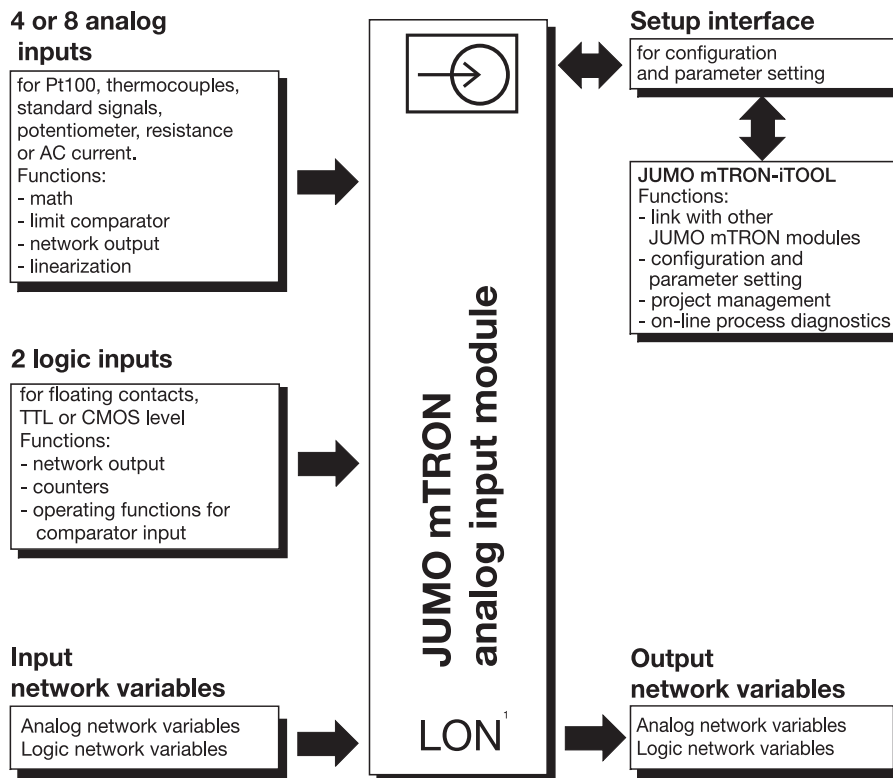

1. LON¹ = Local Operating Network.
 Registered trademark of the
 ECHELON Corporation.

Features

- **Math functions**
 Difference, humidity, ratio, square root, square, minimum, maximum, absolute value, sum, product, mean value
- **Limit comparator**
 Comparator and window functions, direct or reversed, with switch-on and switch-off delay, also latching and gate circuit
- **Customized linearization**
 Linearization function with up to 21 calibration points
- **Range monitoring**
 The analog inputs are monitored against definable limit values
- **Setup interface**
 For configuration and parameter setting the module is linked to a PC via a PC interface
- **Plug-&-Play-Function**
 Problem-free replacement of modules without re-configuration

Technical data

Hardware inputs

Analog inputs

Measurement input

- resistance thermometer
- thermocouples
- standard signals (current/voltage)
- AC current (50/60Hz sinusoidal)
- resistance
- potentiometer

Sampling time

420 msec for all inputs

Functions

- network output
- math function
- customized linearization
- limit comparator

Logic input

activation: floating contact,
TTL or CMOS level

Functions:

- network output
- operating input
for the comparator function

Frequency input

activation: floating contact,
TTL or CMOS level
maximum counting rate: 15kHz

Note: The quoted measurement accuracy is only valid if all analog inputs have sensors connected.
Unused analog inputs must be shorted by a wire jumper.

Sensor	Measurement range ¹	Internal resistance/ voltage drop	Meas. circuit monitoring		Resolution	Measurement accuracy	
			Recognition of sensor break	Recognition of sensor short-circuit		Maximum measurement error ¹ at 23°C	Ambient temperature drift per 10°C
Pt100	-200 to +850°C (-200 to +850°C)		X	X	0.025°C	± 0.4°C	± 0.21°C
Fe-Con L	-200 to +900°C (-200 to +900°C)	47MΩ	X	-	0.05°C	± 1.8°C	± 0.9°C
Fe-Con J	-200 to +1200°C (-100 to +1200°C)	47MΩ	X	-	0.05°C	± 1.8°C	± 1.2°C
NiCr-Ni K	-200 to +1372°C (-100 to +1372°C)	47MΩ	X	-	0.07°C	± 1.9°C	± 1.4°C
Cu-Con U	-200 to +600°C (-100 to +600°C)	47MΩ	X	-	0.07°C	± 1.7°C	± 0.6°C
Cu-Con T	-200 to +400°C (-200 to +400°C)	47MΩ	X	-	0.07°C	± 1.6°C	± 0.4°C
NiCrSi-NiSi N	-100 to +1300°C (-100 to +1300°C)	47MΩ	X	-	0.07°C	± 2.3°C	± 1.3°C
Pt10Rh-Pt S	0 – 1768°C (100 – 1768°C)	47MΩ	X	-	0.3°C	± 3.4°C	± 1.7°C
Pt13Rh-Pt R	0 – 1768°C (100 – 1768°C)	47MΩ	X	-	0.25°C	± 3.4°C	± 1.7°C
Pt30Rh-Pt6Rh B	0 – 1820°C (400 – 1820°C)	47MΩ	X	-	0.3°C	± 4.4°C	± 1.4°C
Standard signals	-50 to +50mV	47MΩ	X	-	2.5µV	± 0.04mV	± 0.05mV
Standard signals	0 – 50mV	47MΩ	X	-	2.5µV	± 0.04mV	± 0.05mV
Standard signals	10 – 50mV	47MΩ	X	X	2.5µV	± 0.04mV	± 0.05mV
Standard signals	-10 to +10V	2MΩ	-	-	500µV	± 8mV	± 15mV
Standard signals	0 – 10V	2MΩ	-	-	500µV	± 8mV	± 15mV
Standard signals	2 – 10V	2MΩ	X	X	500µV	± 8mV	± 15mV
Standard signals	-1 to +1V	2MΩ	-	-	50µV	± 0.8mV	± 1.5mV
Standard signals	0 – 1V	2MΩ	-	-	50µV	± 0.8mV	± 1.5mV
Standard signals	0.2 – 1V	2MΩ	X	X	50µV	± 0.8mV	± 1.5mV
Standard signals	-20 to +20mA	less than 1 V	-	-	1µA	± 15µA	± 30µA
Standard signals	0 – 20mA	less than 1V	-	-	1µA	± 15µA	± 30µA
Standard signals	4 – 20mA	less than 1V	X	X	1µA	± 16µA	± 30µA
AC current	0 – 50mA	less than 1V	-	-	5µA	1mA	± 100µA
Resistance	0 – 400Ω		X	X	0.01 Ω	± 0.15Ω	± 0.1Ω
Potentiometer	0.1 – 10KΩ		X (slider)	-	0.01 %	0.25 %	0.1 %

X: recognized - : not recognized

1. The accuracy given refers to the ranges given in brackets. With thermocouples, the accuracy is obtained only in the specified operating position and after an operating time of at least 1 hour.

Displays and controls

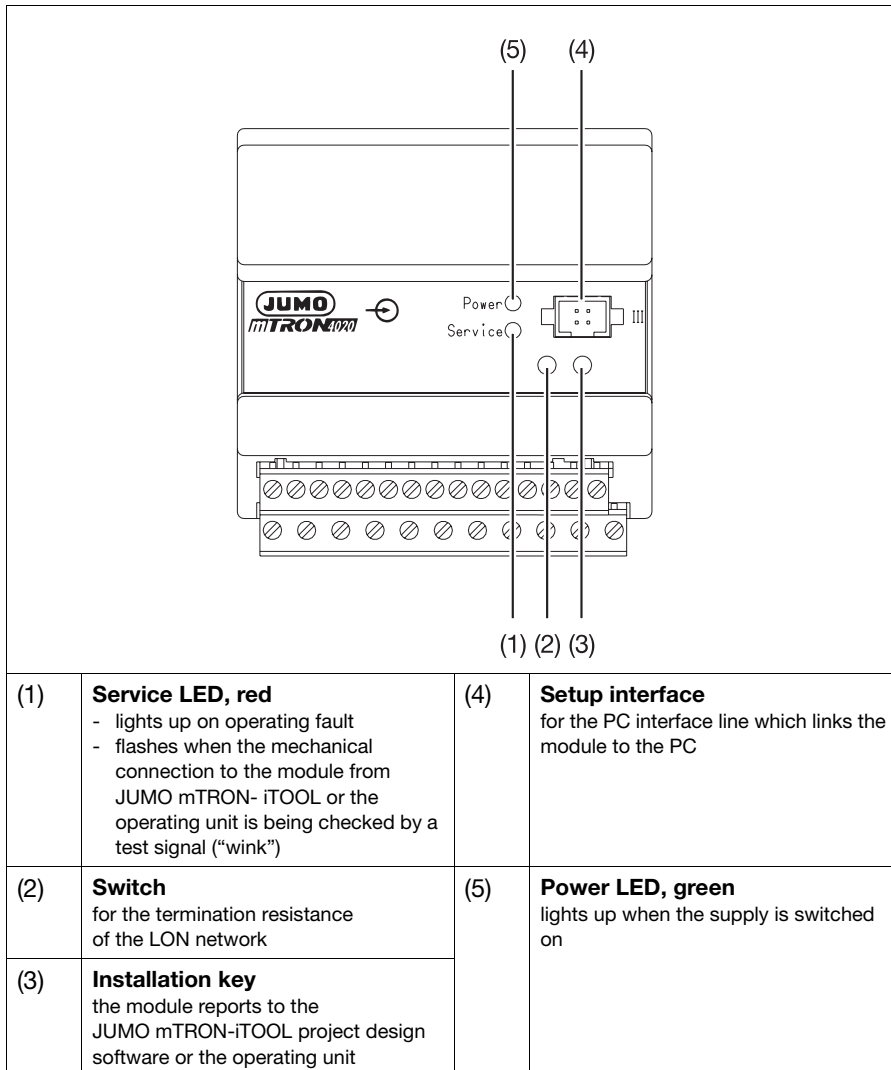

Input network variables

Analog network variables

Functions:

- math function
- customized linearization
- limit comparator

Logic network variable

Function:

- operating input for the comparator function

Output network variables

Analog network variables

Output cycle: 420 msec — 8.4sec, adjustable

Functions:

- measurement analog input 1 — 4 (8)
- output for math
- output for linearization 1 — 4 (8)

Frequency input

Output cycle: 0.8388608sec

Function:

- output of the pulses counted at fixed intervals

Logic network variables

Output cycle: event-controlled but at least every 14sec

Functions:

- limit comparator output
- output of the logic input
- monitoring of the analog inputs
- monitoring of the network inputs (combined alarm)

General data

Electrical safety

as per EN 61010-1
Overvoltage category: II
Pollution degree: 2

Environmental influences

Operating and ambient temperature: 0 to 55°C
Permitted storage temperature: -40 to +70°C
Relative humidity: rH 80 % max.
Electromagnetic compatibility as per EN 61326-1
- interference emission: Class A - Only for industrial use -
- interference immunity: to industrial requirements

Housing

Material: plastic, self-extinguishing
Flammability Class: UL 94 VO
Protection: IP20 (to EN 60 529)
Mounting: on standard rail

Supply

110 — 240 V AC +10/-15%, 48 — 63Hz, or 20 — 53 V AC/DC, 48 — 63Hz
Power consumption: 5 VA max.

Network (LON interface)

Topology: free topology FTT-10A (ring, star, line or mixed structure)
Baud rate: 78 kbaud
Max. lead length (depending on lead type):
line: 2700m
star: 500m
ring: 500m
mixed: 500m
Max. number of modules: 64

Operation and project design

Operation, parameter setting and configuration of JUMO mTRON modules can be carried out from the JUMO mTRON operating unit.

The JUMO mTRON-iTOOL project design software permits convenient design and start-up of a JUMO mTRON system.

The projects can be archived and documented. Individual modules are linked via LON by assigning network variable (NV) names.

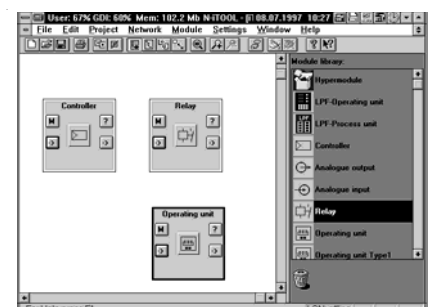

Connection diagram for Type 704020/0-

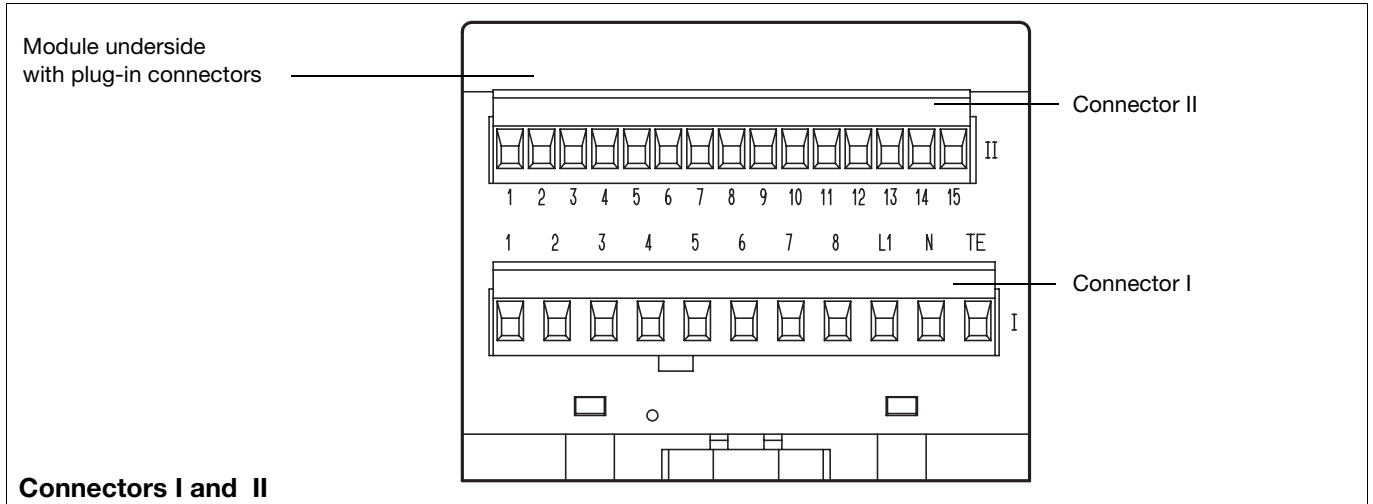

Connectors I and II

Connection for	Terminals				Notes	Diagram
	Input 1	Input 2	Input 3	Input 4		
Thermocouple	I_4+ I_3-	I_8+ I_7-	II_8 + II_7 -	II_12 + II_11 -		
Resistance thermometer in 3-wire circuit resistance 0 – 400Ω with 3-wire connection	I_4 I_2 I_3	I_8 I_6 I_7	II_8 II_6 II_7	II_12 II_10 II_11		
Resistance thermometer in 2-wire circuit resistance 0 – 400Ω with 3-wire connection	I_2 I_4 I_3	I_6 I_8 I_7	II_6 II_8 II_7	II_10 II_12 II_11	$R_A = R_{lead}$	
Potentiometer	I_2 I_4 I_3	I_6 I_8 I_7	II_6 II_8 II_7	II_10 II_12 II_11	E = end S = slider A = start	
Voltage 0 – 10mV 10 – 50mV -50 to +50mV	I_4+ I_3-	I_8+ I_7-	II_8 + II_7 -	II_12 + II_11 -		
Voltage input 0 – 1V / 0.2 – 1V -1 to +1V 0 – 10V / 2 – 10V -10 to +10V	I_1+ I_3-	I_5+ I_7-	II_5 + II_7 -	II_9 + II_11 -		
Current 0 – 20mA 4 – 20mA	I_4+ I_3-	I_8+ I_7-	II_8 + II_7 -	II_12 + II_11 -		

Connection for	Terminals				Notes	Diagram
	Input 1	Input 2	Input 3	Input 4		
Analog inputs						
AC current 0 – 50mA			II_7 II_8	II_11 II_12		
Logic input floating contact TTL or CMOS level	II_1 II_2					
Frequency input floating contact TTL or CMOS level	II_1 II_3					
LON interface	II_13 = TE			screen		
	II_14 = Net_A II_15 = Net_B			any polarity		
Technical earth	II_13					
Supply as label	AC		DC			
	I_L1 line I_N neutral I_TE technical earth		I_L1 } any I_N } polarity I_TE technical earth			

Dimensions

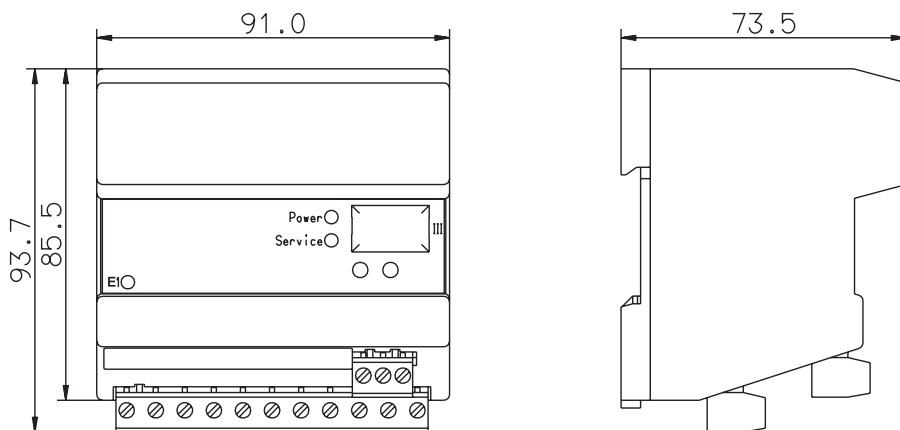

Connection diagram for Type 704020/1-

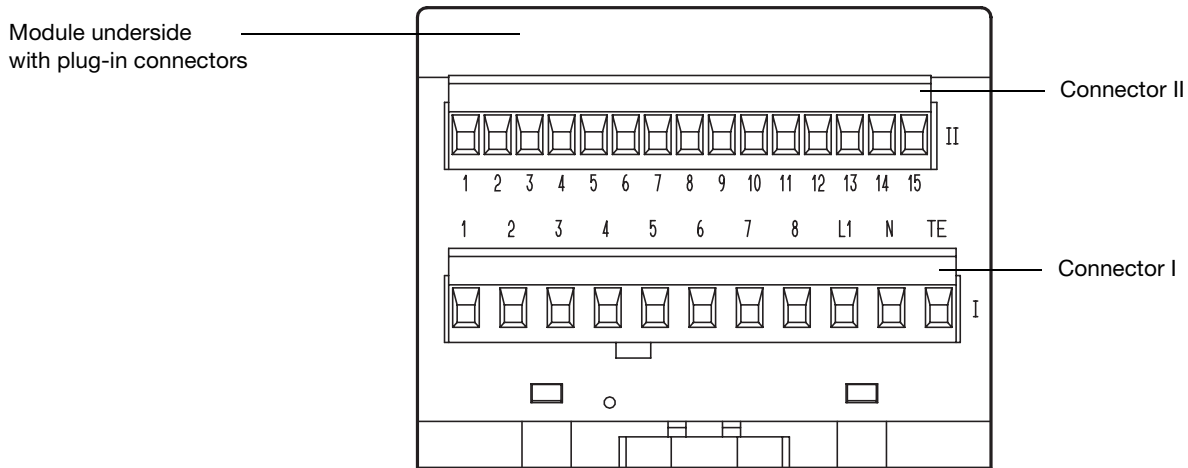

Connection for	Terminals								Diagram
Analog inputs	1	2	3	4	5	6	7	8	
Resistance thermometer Pt100 and Pt1000 in 2-wire circuit	I_1 I_2	I_3 I_4	I_5 I_6	I_7 I_8	II_5 II_6	II_7 II_8	II_9 II_10	II_11 II_12	I_1 I_2 I_3 I_4 I_5 I_6 I_7 I_8 II_5 II_6 II_7 II_8 II_9 II_10 II_11 II_12
Voltage 0 – 10V 2 – 10V Current 0 – 20mA 4 – 20mA	I_1+ I_2-	I_3+ I_4-	I_5+ I_6-	I_7+ I_8-	II_5+ II_6-	II_7+ II_8-	II_9+ II_10-	II_11+ II_12-	I_1 I_2 I_3 I_4 I_5 I_6 I_7 I_8 II_5 II_6 II_7 II_8 II_9 II_10 II_11 II_12
Logic input 1 floating contact TTL or CMOS level	II_1 II_2								
Logic input 2 floating contact TTL or CMOS level	II_1 II_3								

LON interface	II_13 = TE	screen	II 15 II 14 II 13
	II_14 = Net_A II_15 = Net_B	any polarity	
Technical earth	II_13		
Supply as label	AC	DC	
	I_L1 line I_N neutral I_TE technical earth	I_L1 any polarity I_N any polarity I_TE technical earth	I_L1 I_N I_TE

Isolation

Type 704020-0

Type 704020-1

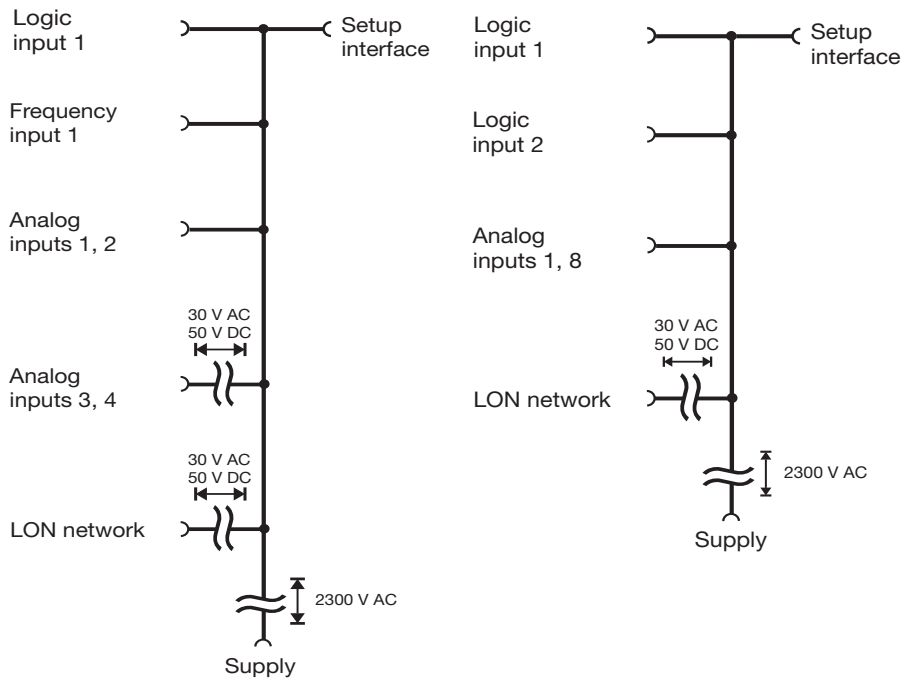

Ordering details

704020/0- -

(1) Analog inputs

Standard version 888

Measurement input	Inputs			
	1	2	3	4
Pt100 resistance thermometer	X	X	X	X
Thermocouples Fe-Con L Fe-Con J NiCr-Ni K Cu-Con U Cu-Con T NiCrSi-NiSi N Pt10Rh-Pt S Pt13Rh-Pt R Pt30Rh-Pt6Rh B				
Standard signals 0 – 50 mV 10 – 50 mV -50 to +50 mV 0 – 1 V 0.2 – 1 V -1 to +1 V 0 – 10 V 2 – 10 V -10 to +10 V 0 – 20 mA 4 – 20 mA				
AC current 0 – 50mA				
Resistance 0 – 400Ω				
Potentiometer 0.1 – 10KΩ				

Special version 999

Factory-configured to customer specification. Please specify inputs in plain language, see table.

(2) Supply

Type	Code
110 – 240V AC +10/-15%, 48 – 63Hz	23
20 – 53V AC/DC, 48 – 63Hz	22

X = factory-set, freely programmable

Ordering details

704020/1- -

(1) Analog inputs

Standard version 888

Measurement input	Inputs 1 – 8
Pt100 resistance thermometer in 2-wire circuit	179
Pt1000 resistance thermometer in 2-wire circuit	180
Standard voltage signals: (switchable via JUMO mTRON-iTOOL) 0 – 10 V 2 – 10 V	181
Standard current signals: (switchable via JUMO mTRON-iTOOL) 0 – 20 mA 4 – 20 mA	182

Special version 999

(2) Supply

Type	Code
110 – 240V AC +10/-15%, 48 – 63Hz	23
20 – 53V AC/DC, 48 – 63Hz	22

Standard accessory

1 Installation instructions B 70.4020.4

Accessories

PC interface

with TTL/RS232C converter

for connecting the module to a PC; length 2m.

Sales No. 70/00301315

Project design software

JUMO mTRON-iTOOL

Using the JUMO mTRON-iTOOL project design software, the modules can be designed graphically on the PC. The user is able to link modules of the JUMO mTRON family and to configure the application-specific parameters.

System Manual JUMO mTRON

Documentation of configuration, parameter setting and installation of the modules.

Sales No. 70/00334336

JUMO mTRON modules

Controller module

Data Sheet 70.4010

Relay module

Data Sheet 70.4015

Analog input module

Data Sheet 70.4020

Analog output module

Data Sheet 70.4025

Logic module

Data Sheet 70.4030

Operating unit

Data Sheet 70.4035

Communication module

Data Sheet 70.4040

Project design software

JUMO mTRON-iTOOL

Data Sheet 70.4090