

JUMO GmbH & Co. KG
 Delivery address: Mackenrodtstraße 14
 36039 Fulda, Germany
 Postal address: 36035 Fulda, Germany
 Phone: +49 661 6003-0
 Fax: +49 661 6003-607
 Email: mail@jumo.net
 Internet: www.jumo.net

JUMO Instrument Co. Ltd.
 JUMO House
 Temple Bank, Riverway
 Harlow, Essex CM 20 2DY, UK
 Phone: +44 1279 63 55 33
 Fax: +44 1279 62 50 29
 Email: sales@jumo.co.uk
 Internet: www.jumo.co.uk

JUMO Process Control, Inc.
 6733 Myers Road
 East Syracuse, NY 13057, USA
 Phone: +1 315 437 5866
 Fax: +1 315 437 5860
 Email: info.us@jumo.net
 Internet: www.jumousa.com



JUMO dTRANS AS 02

Transmitter/controller for standard signals and temperature

Brief description

The JUMO dTRANS AS 02 is a compact, modular instrument. It is highly flexible (for example 3 slots for optional boards) and capable of performing a wide range of tasks. Resistance thermometers Pt100 or Pt1000, NTC/PTC or standard signals 0(4) to 20 mA or 0 to 10 V can be connected to the main input of the JUMO dTRANS AS 02. The two binary inputs can be used as initiators for actions (for example HOLD, keypad lock). The high-contrast graphic display allows for several options including display of input signal with numbers or as bar graph. Parameters are displayed in plain text for easily comprehensible and reliable operation.

The JUMO dTRANS AS 02 can be used as a two-point or three-point controller, a three-point modulating controller, or as a continuous controller. All controller outputs can be configured to P, PI, PD or PID action. The software for the controllers includes parameter set selection, a math module and more.

A setup program is available for convenient configuration via PC. The instrument can be integrated into a data network by means of an RS422/485 or PROFIBUS-DP interface. Screw terminals on the back are used for the electrical connection.

Some applications:

- Free chlorine, total chlorine, hydrogen peroxide, peracetic acid, chlorine dioxide and ozone in combination with sensors as per data sheet 20263X.
- The pH value or redox potential with 2-wire transmitter JUMO digiLine – intelligent electronics with analog output type 202705/20-86-888.
- (Hydrostatic) liquid levels with 2-wire transmitters (level and pressure measuring instruments) as per data sheet 402090 or data sheet 404391.
- Flow rate in combination with relevant transmitters.
- Two temperature measuring points.

Block diagram

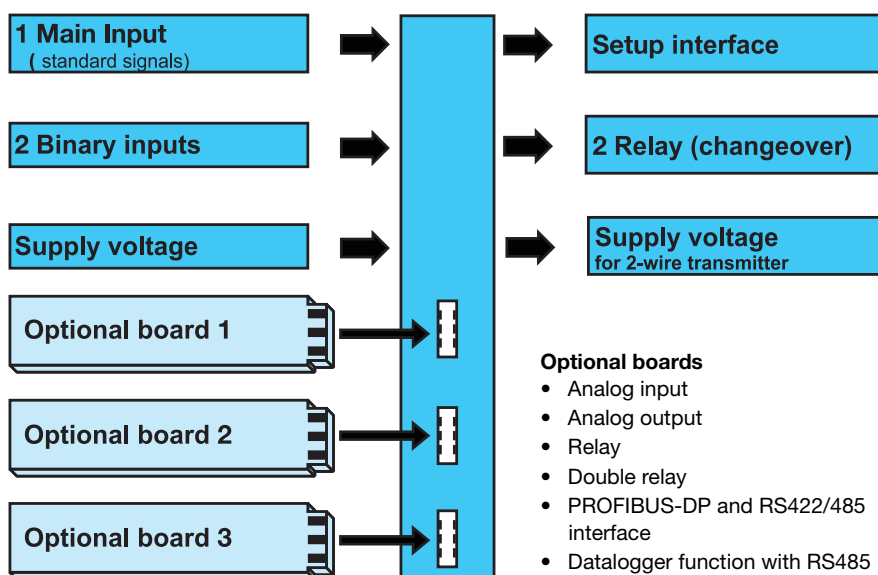

Approval/approval marks (see Technical data)



JUMO dTRANS AS 02, type 202553/01... in panel case



JUMO dTRANS AS 02, type 202553/05... in surface-mounted case

Special features

- Display: mg/l, pH, mV, $\mu\text{S}/\text{cm}$, etc. Special visualizations are also possible with the setup program
- A choice of display visualizations: large numbers, bar graph or tendency (trend) display
- Integrated calibration routines: 1-point and 2-point
- Math and logic module
- Calibration logbook
- Integrated washing timer to control the cleaning equipment
- 13 operator languages integrated; see order details
- Setup program provides: convenient programming, system documentation
- Flush-mounted instrument - just 96 mm x 48 mm x 95 mm

JUMO GmbH & Co. KG
 Delivery address: Mackenrodtstraße 14
 36039 Fulda, Germany
 Postal address: 36035 Fulda, Germany
 Phone: +49 661 6003-0
 Fax: +49 661 6003-607
 Email: mail@jumo.net
 Internet: www.jumo.net

JUMO Instrument Co. Ltd.
 JUMO House
 Temple Bank, Riverway
 Harlow, Essex CM 20 2DY, UK
 Phone: +44 1279 63 55 33
 Fax: +44 1279 62 50 29
 Email: sales@jumo.co.uk
 Internet: www.jumo.co.uk

JUMO Process Control, Inc.
 6733 Myers Road
 East Syracuse, NY 13057, USA
 Phone: +1 315 437 5866
 Fax: +1 315 437 5860
 Email: info.us@jumo.net
 Internet: www.jumousa.com



Boards

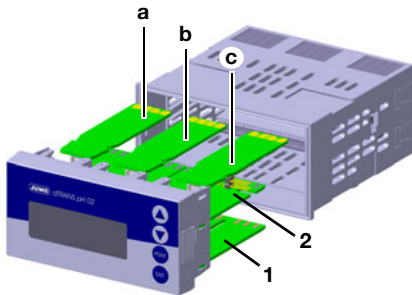

(1)	PSU board
(2)	Main board
(a)	Optional board 1
(b)	Optional board 2
(c)	Optional board 3

PSU board (1)

This board is always fitted in the instrument and no variations are possible.

The board includes the following items:

- The voltage supply for the JUMO dTRANS AS 02.
- The voltage supply for external 2-wire transmitters.
- 2 relays with changeover contacts.

Main board (2)

This board can **not** be changed subsequently! The main board (AS) has:

- The main input for connecting a temperature sensor Pt100, Pt1000, a resistance transmitter or a standard signal 0(4) to 20 mA or 0 to 10 V.
- 2 binary inputs.
- The setup interface (for PC interface adapter).

Optional board (1), (2) or (3)

These boards are combinable and can be ordered in the following versions:

- 1 analog input
- 1 continuous output
- 1 relay (changeover)
- 2 relays (NO with common pin)
- 1 Triac (1 A)
- 1 PhotoMOS® relay (0.2 A)

The following boards can **only** be placed in slot 3, either:

- Modbus/Jbus
- PROFIBUS-DP
- Datalogger

For versions with a wall-mounted case the (re)placement of the optional boards by the customer is not possible.

Functional description

The instrument is a modularly designed indicator/controller for use in both simple and demanding control tasks. It can be integrated into the PLC via interfaces

To make programming and operation easy, all parameters are clearly assigned to levels and displayed in plain text. Operation is protected by a code word. Operation can be adapted on an individual basis because parameters can be generally enabled or assigned to the protected area.

A setup program for the PC is available as a more convenient configuration option, rather than using the instrument keypad.

User data

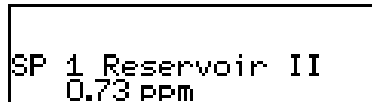

Up to 8 parameters that are frequently changed by the user can be combined in the user level under "User data" (via setup program only).

Displays and controls

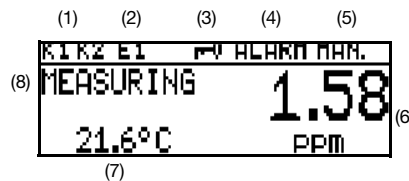

(1)	Binary outputs (relays) Output active if symbol is visible.
(2)	Binary input Input closed if symbol is visible.
(3)	Keypad lock Keys locked if symbol is visible.
(4)	Alarm message ALARM (flashing): Broken sensor or overrange, etc. AL R1: Controller monitoring alarm from controller channel 1. AL R2: Controller monitoring alarm from controller channel 2. CALIB (flashing): Calibration mode active. CALIB (flashing): Calibration timer elapsed.
(5)	Output mode MAN.: Manual mode active. HOLD: Hold mode active.
(6)	Top display Measured value and unit of the variable set by parameter "Top display".

(7)	Bottom display Measured value and unit of the variable set by parameter "Bottom display".
(8)	Operating mode MEASURING: Standard measuring mode is active.

Display modes

The following display modes are available:

Normal display

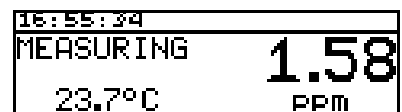

In this display method the measurements appear in numbers, as usual.

Large display

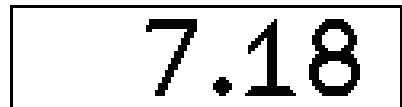

This method uses the complete display height.

Tendency display

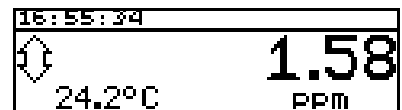

In this display a symbol is added to the numerical value to indicate the direction and speed of change for the measurement value. This can be very useful for optimizing the controller, for example.

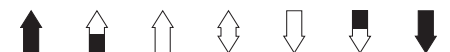

From left to right:

Fast, medium and slow rise, steady, slow, medium and fast fall.

Bar graph



In this display mode, it only takes a glance to ascertain the range for the current measurement. Any scale can be used for the bar graph.

Tendency curve (data monitor)



The ring buffer contains about 100 measuring points. The sampling and storage rates can be adjusted.

JUMO GmbH & Co. KG

Delivery address: Mackenrodtstraße 14
36039 Fulda, Germany
Postal address: 36035 Fulda, Germany
Phone: +49 661 6003-0
Fax: +49 661 6003-607
Email: mail@jumo.net
Internet: www.jumo.net

JUMO Instrument Co. Ltd.

JUMO House
Temple Bank, Riverway
Harlow, Essex CM 20 2DY, UK
Phone: +44 1279 63 55 33
Fax: +44 1279 62 50 29
Email: sales@jumo.co.uk
Internet: www.jumo.co.uk

JUMO Process Control, Inc.

6733 Myers Road
East Syracuse, NY 13057, USA
Phone: +1 315 437 5866
Fax: +1 315 437 5860
Email: info.us@jumo.net
Internet: www.jumousa.com



Function modes of the main board

Main board input

0(4) to 20 mA; 0 to 10 V and Pt100/Pt1000/
NTC/PTC (max. 30 k Ω)/cust. specs.

Typical application: Compensation input for
temperature compensation of the main
measurement variable.

Linear scaling

Select this mode when the input signal will be
displayed linearly.

One of the following units is used for display
or control:

- μ S/cm
- mS/cm
- %
- mV
- pH
- ppm
- Cust. specs. (5 characters)

Sensors can be connected to the instrument
for the following measurement variables, for
example:

- Free chlorine, chlorine dioxide, ozone,
hydrogen peroxide and peracetic acid as
per data sheet 202630.
- pH value odr Redox potential.
- Liquid level measurements.
- Flow rate measurements.
- etc.

The instrument has three calibration options
available in this function mode:

- Zero point
- Limit value
- Zero point and limit value

This allows optimum adaptation of the
instrument to the sensor.

Conductivity

This mode is intended for sensors that make
uncorrected standard signals available. μ S/
cm or mS/cm are the units used for display or
control.

Different calibration routines can be activated:

- Calibrating the cell constant.
Because of manufacturing constraints,
the cell constant of a conductivity
measuring cell may differ slightly from its
nominal value (the value printed on it).
Wear or the accumulation of deposits
during operation can also cause the cell
constant to change. This changes the
output signal from the measuring cell.
With this instrument, the user has the
opportunity to compensate for deviations
in the nominal value of the cell constant
by **manual input** (80 to 120 % range) or
automatic calibration of the relative cell
constant K_{rel} .
- Calibrating the temperature coefficient α .
The conductivity of virtually all solutions is
temperature-dependent. To ensure
correct measurement both the

temperature and the temperature
coefficient α [%/K] of the measurement
solution must therefore be known. The
temperature can either be measured
automatically with a Pt100 or Pt1000
temperature probe or the user must set
the temperature by hand.

The temperature coefficient can be
determined automatically by the
instrument or entered manually in the
0 to 5.5 %/K range.

Concentration

In this mode, the concentration of a liquid can
be determined from its uncompensated
conductivity.

% or "Cust. specs." are the units used for
display and control.

Concentration measurement:

Caustic soda

NaOH 0 to 15 % by weight

NaOH 25 to 50 % by weight

Nitric acid

HNO₃ 0 to 25 % by weight

HNO₃ 36 to 82 % by weight

Sulfuric acid

H₂SO₄ 0 to 28 % by weight

H₂SO₄ 36 to 85 % by weight

H₂SO₄ 92 to 99 % by weight

Hydrochloric acid

HCl 0 to 18 % by weight

HCl 22 to 44 % by weight

The cell constant can be calibrated.

pH or redox

Connection option for transmitters that emit
an uncalibrated pH or redox standard
signal, such as 2-wire transmitter JUMO
digiLine – intelligent electronics with analog
output type 202705/20-86-888.

The dTRANS AS 02 provides the required
voltage supply for this type of 2-wire
transmitter.

pH: a pH calibration (zero point or zero point
and slope) can be performed, as well as the
option of temperature compensation. "pH"
display and control variable.

Redox: Both relative and absolute calibration
are possible (zero point or as a percentage,
using reference values). "mV" or "%" display
and control variables.

Cust. specs. with table

Non-linear correlations between the input and
output variable can be processed in this
mode. Typical applications include measuring
the level of liquid in horizontal, cylindrical
containers or simply measuring the
concentration.

The input values are processed in a table
(max. 20 value pairs). Values can only be
entered in the table using the optional setup
program.

The units used for display and control are:

- μ S/cm
- mS/cm
- Cust. specs. (5 characters)
- Use the offset parameter to adjust the
display.

Temperature compensation

The instrument is able to perform an
automatic temperature compensation.

The conductivity or resistance of aqueous
solutions often depends greatly on the
temperature. The instrument provides the
following procedures for temperature
compensation, depending on the display size:

- Off (e.g. USP)
- Linear
- ASTM
- Natural waters (EN 27888/ISO 7888)

Function modes of the optional inputs, "Multi-channel mode"

If analog inputs have been fitted (optional
board), the device will have multi-channel
functions. The following signal types can be
processed:

- 0(4) to 20 mA
- 0 to 10 V
- Pt100/Pt1000

Sensors that return one of the output signals
listed above can be connected to the
instrument for the following measurement
variables, for example:

- Free chlorine, chlorine dioxide, ozone,
hydrogen peroxide and peracetic acid as
per data sheet 202630.
- pH value or redox potential as per data
sheet 202705.
- Liquid level measurements.
- Flow rate measurements.
- etc.

The instrument provides the following
calibration options in this function mode:

- Zero point
- Limit value
- Zero point and limit value
- Cell constant
- Temperature coefficient

This allows optimum adaptation of the
instrument to the sensor.

Linear scaling

Select this mode when the input signal will be
displayed linearly.

One of the following units is used for display
or control:

- μ S/cm
- mS/cm
- %
- mV
- pH
- ppm
- Cust. specs. (5 characters)

JUMO GmbH & Co. KG

Delivery address: Mackenrodtstraße 14
36039 Fulda, Germany
Postal address: 36035 Fulda, Germany
Phone: +49 661 6003-0
Fax: +49 661 6003-607
Email: mail@jumo.net
Internet: www.jumo.net

JUMO Instrument Co. Ltd.

JUMO House
Temple Bank, Riverway
Harlow, Essex CM 20 2DY, UK
Phone: +44 1279 63 55 33
Fax: +44 1279 62 50 29
Email: sales@jumo.co.uk
Internet: www.jumo.co.uk

JUMO Process Control, Inc.

6733 Myers Road
East Syracuse, NY 13057, USA
Phone: +1 315 437 5866
Fax: +1 315 437 5860
Email: info.us@jumo.net
Internet: www.jumousa.com

**Electrolytic conductivity**

$\mu\text{S/cm}$ or mS/cm are the units used for display and control.

Specific resistance (ultra-pure water)

Display/control with the unit $\text{k}\Omega \times \text{cm}$ or $\text{M}\Omega \times \text{cm}$.

TDS

Display/control with the unit ppm.

The specific TDS factor can also be entered in this mode.

Concentration

In this mode, the concentration of a liquid can be determined from its uncompensated conductivity.

% or "Cust. specs." are the units used for display and control.

Concentration measurement:

Caustic solution

NaOH 0 to 15 % by wt. 0 to 90 °C

NaOH 25 to 50 % by wt. 0 to 90 °C

Nitric acid

HNO₃ 0 to 25 % by wt. 0 to 80 °C

HNO₃ 36 to 82 % by wt. to20 to 80 °C

Sulfuric acid

H₂SO₄ 0 to 28 % by wt. 0 to 100 °C

H₂SO₄ 36 to 85 % by wt. 0 to 115 °C

H₂SO₄ 92 to 99 % by wt. 0 to 115 °C

Hydrochloric acid

Hal 0 to 18 % by wt. 0 to 65 °C

Hal 22 to 44 % by wt. -20 to 65 °C

Cust. specs. with table

Non-linear correlations between the input and output variable can be processed in this mode. Typical applications include measuring the level of liquid in horizontal, cylindrical containers or simply measuring the concentration.

The input values are processed in a table (max. 20 value pairs). Values can only be entered in the table using the optional setup program.

The units used for display and control are:

- $\mu\text{S/cm}$
- mS/cm
- Cust. specs. (5 characters)
- Use the offset parameter to adjust the display.

Calibration**Calibration logbook**

The last five successful calibrations can be accessed from the calibration logbook. This makes it possible to evaluate the aging of the connected sensor.

The logbook can be deleted if necessary (useful when changing the sensor).

If a datalogger has been fitted (optional board), additional information such as the date and time are documented.

Calibration timer

The calibration timer indicates (on request) a required routine calibration. The calibration timer is activated by entering the number of days that must expire before there is a scheduled re-calibration (specified by the system or the operator).

Additional functions of the JUMO dTRANS AS 02**Min/max value memory**

This storage records the minimum and maximum input quantities that have occurred. This information can be used, for example, to assess whether the design of the connected sensor is suitable for the values that actually occur.

Binary input

The following functions can be accessed through the binary input:

- Key lock activation
When this function is activated, operation is no longer possible via the keypad.
- "HOLD" mode activation
When this function is activated, the outputs (analog and relay) adopt the states previously defined.
- Alarm suppression (controller alarm only)
This function is used to temporarily deactivate alarm generation by means of the appropriately configured relay.

Bridging the corresponding connection terminals with a floating contact (for example a relay) activates a predefined function.

Wash timer

A software function can be used to trigger cyclically recurring actions by controlling a relay.

Control functions

Functions can be assigned to the relays. The functions can be configured in turn by parameters P, PI, PD and PID structures can be freely programmed as control functions.

Relay outputs

Two relay changeover contacts are available for the main measurement variable and/or the temperature.

The following functions can be programmed:

- Switching direction (min/max)
- Limit controller (on-delay/delayed release, hysteresis)
- Pulse length output (see control functions)
- Pulse frequency output (see control functions)

- Modulating function (see control functions)
- Pulse functions
With this function, the output briefly switches on when the switching point is reached and then switches off again
- Wash timer elapsed
- Alarm
- Sensor/range error
- Behavior in the event of an alarm, underrange or overrange measurement, calibration and "HOLD"

Datalogger

Up to 43,500 data sets can be stored in the datalogger (ring buffer). Depending on the resolution, that corresponds to a storage time ranging from about 10 hours to 150 days.

Data can be read by means of the setup program and then further processed with an "Office" product.

The datalogger makes it possible to record and document processes and supports analysis of the same processes.

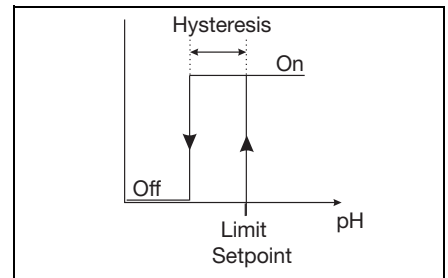
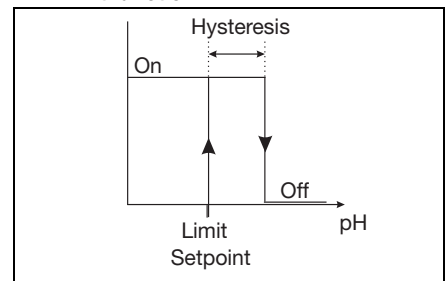
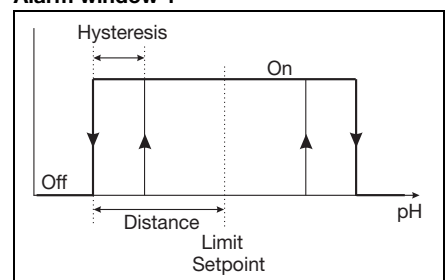
Contact functions**Max. limit function****Min. limit function****Alarm window 1**



Alarm window 2

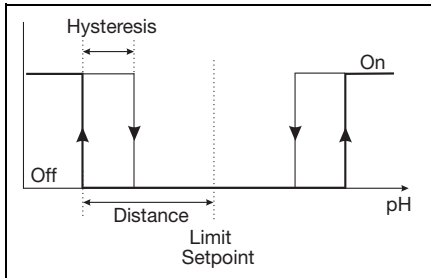

Pulse contact: Triggering condition longer than pulse duration

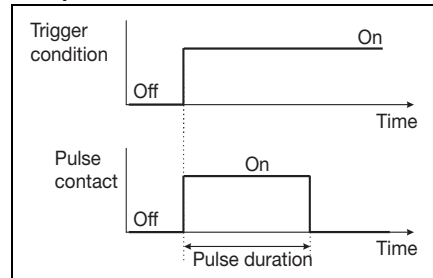

Pulse contact: Triggering condition shorter than pulse duration

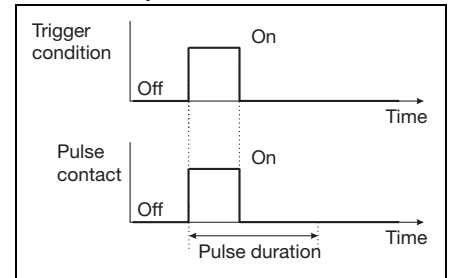

Pulse width controller (output active with $x > w$ and P control structure)

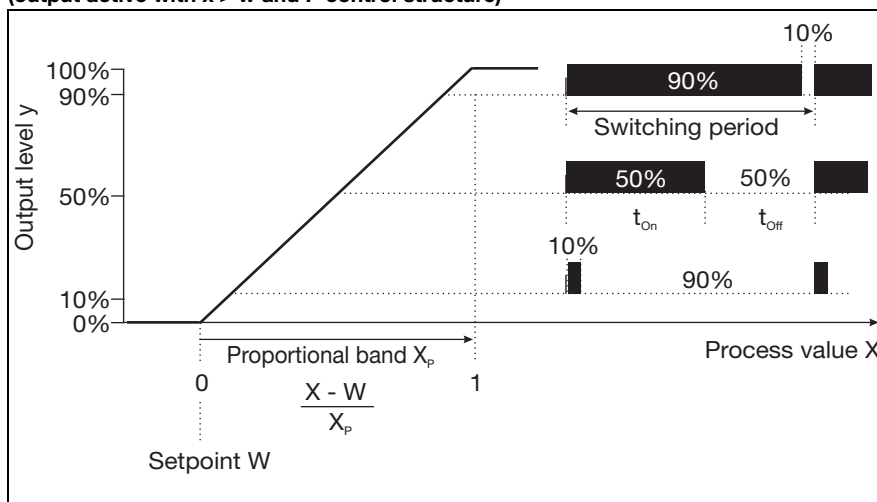

If actual value x exceeds setpoint w , the P controller will control in proportion to the control deviation. When the proportional range is exceeded, the controller operates with an output level of 100 % (100 % clock ratio).

Pulse frequency controller (output active with $x > w$ and P control structure)

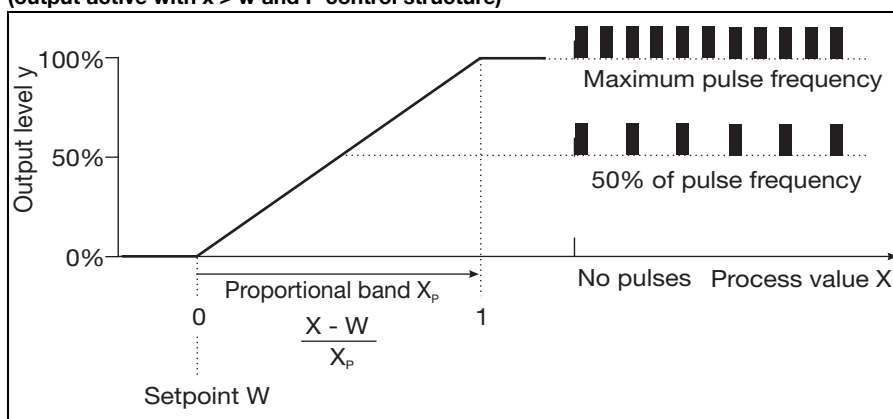

If actual value x exceeds setpoint w , the P controller will control in proportion to the control deviation. When the proportional range is exceeded, the controller operates with an output level of 100 % (maximum switching frequency).

Math and logic module

The math module makes it possible to integrate measurement value of the analog inputs into a mathematical formula so that the calculated process variable can be displayed.

The logic module can be used, for example, to link binary inputs and limit comparators with each other logically.

Up to two math or logic formulas can be entered with the optional setup program and the results of calculations can be displayed or exported via outputs (via PC setup software only).

Setup PC program (accessory)

The setup PC program is available in German, English and French for configuring the instrument. You can use it to create and edit sets of data and transfer them to the instrument, as well as read them out from it. The data can be stored and printed (via PC setup software only).

Setup interface

The setup interface is integrated into the JUMO dTRANS AS 02 by default. You can use it, together with the setup program (accessory) and a setup interface (accessory), to configure the instrument.

RS232/RS485 interface

The serial interface is used for communication with higher-level systems when the Modbus/Jbus protocol is used.

PROFIBUS-DP

The JUMO dTRANS AS 02 can be integrated into a fieldbus system according to the PROFIBUS-DP standard via the PROFIBUS-DP interface. This PROFIBUS-DP version is specially designed for communication between automation systems and distributed peripheral devices at the field level and is optimized for speed.

Data is transferred serially based on the RS485 standard.

JUMO GmbH & Co. KG
 Delivery address: Mackenrodtstraße 14
 36039 Fulda, Germany
 Postal address: 36035 Fulda, Germany
 Phone: +49 661 6003-0
 Fax: +49 661 6003-607
 Email: mail@jumo.net
 Internet: www.jumo.net

JUMO Instrument Co. Ltd.
 JUMO House
 Temple Bank, Riverway
 Harlow, Essex CM 20 2DY, UK
 Phone: +44 1279 63 55 33
 Fax: +44 1279 62 50 29
 Email: sales@jumo.co.uk
 Internet: www.jumo.co.uk

JUMO Process Control, Inc.
 6733 Myers Road
 East Syracuse, NY 13057, USA
 Phone: +1 315 437 5866
 Fax: +1 315 437 5860
 Email: info.us@jumo.net
 Internet: www.jumousa.com



Technical data

Inputs (main board)

	Measuring range/control range	Accuracy	Effect of temperature
Standard signal	0(4) to 20 mA, 0 to 1 V, 0 to 10 V	0.25 % of range	0.2 %/10 K
Secondary input			
Temperature Pt100/1000	-50 to +250 °C ^a	≤ 0.25 % of range	0.2 %/10 K
Temperature NTC/PTC	0.1 to 30 kΩ Entry via table with 20 value pairs	≤ 1.5 % of range	0.2 %/10 K
Resistance transmitter	Minimum: 100 Ω Maximum: 3 kΩ	±5 Ω	0.1 %/10 K

^a Selectable in °F.

Resistance thermometer inputs (optional board)

Designation	Connection	Measuring range	Measuring accuracy		Effect of ambient temperature
			3-wire/4-wire	2-wire	
Pt100 DIN EN 60751 (factory-set)	2-wire/3-wire/ 4-wire	-200 to +850 °C	≤ 0.05 %	≤ 0.4 %	50 ppm/K
Pt1000 DIN EN 60751 (factory-set)	2-wire/3-wire/ 4-wire	-200 to +850 °C	≤ 0.1 %	≤ 0.2 %	50 ppm/K
Sensor lead resistance	Maximum 30 Ω per line with 3- and 4-wire circuit				
Measurement current	Approx. 250 µA				
Lead compensation	Not required for 3- and 4-wire circuit. With a 2-wire circuit, lead resistance can be compensated in the software by correcting the process value.				

Standard signals inputs (optional board)

Designation	Measuring range	Measuring accuracy	Effect of ambient temperature
Voltage	0(2) to 10 V, 0 to 1 V Input resistance _E > 100 kΩ	≤ 0.05 %	100 ppm/K
Electrical current	0(4) to 20 mA, voltage drop ≤ 1.5 V	≤ 0.05 %	100 ppm/K
Resistance transmitter	Minimum: 100 Ω Maximum: 4 kΩ	±4 Ω	100 ppm/K

Temperature compensation for conductivity

Type of compensation	Range ^a
Linear 0 to 8 %/K	-10 to +160 °C
ASTM D1125 - 95 (ultra-pure water)	0 to 100 °C
Natural waters (ISO 7888)	0 to 36 °C
Reference temperature	
Adjustable from 15 to 30 °C; preset to 25 °C (default)	

^a Note the sensor operating temperature range!

Measuring circuit monitoring

Inputs	Underrange/overrange	Short circuit	Broken lead
Temperature	Yes	Yes	Yes
Voltage	2 to 10 V	Yes	Yes
	0 to 10 V	No	No
	0 to 1 V	No	No
Current	4 to 20 mA	Yes	Yes
	0 to 20 mA	No	No
Resistance transmitter	No	No	Yes

JUMO GmbH & Co. KG
 Delivery address: Mackenrodtstraße 14
 36039 Fulda, Germany
 Postal address: 36035 Fulda, Germany
 Phone: +49 661 6003-0
 Fax: +49 661 6003-607
 Email: mail@jumo.net
 Internet: www.jumo.net

JUMO Instrument Co. Ltd.
 JUMO House
 Temple Bank, Riverway
 Harlow, Essex CM 20 2DY, UK
 Phone: +44 1279 63 55 33
 Fax: +44 1279 62 50 29
 Email: sales@jumo.co.uk
 Internet: www.jumo.co.uk

JUMO Process Control, Inc.
 6733 Myers Road
 East Syracuse, NY 13057, USA
 Phone: +1 315 437 5866
 Fax: +1 315 437 5860
 Email: info.us@jumo.net
 Internet: www.jumousa.com



Binary input

Activation	Floating contact is open: function is not active Floating contact is closed: function is active
Function	Key lock, manual mode, HOLD, HOLD inverse, alarm suppression, freeze measured value, level lock, reset day counter, reset total counter, parameter set switchover

Controller

Controller type	Limit comparators, limit controllers, pulse length controllers, pulse frequency controllers, modulating controllers, continuous controllers
Controller structure	P/PI/PD/PID

Outputs

Relay (changeover) Contact rating Contact service life	PSU board	5 A at AC 240 V resistive load 350,000 operations at nominal load/750,000 operations at 1 A
Voltage supply for 2-wire transmitter	PSU board	Electrically isolated, non-controlled DC 17 V at 20 mA, open-circuit voltage approx. DC 25 V
Voltage supply for inductive proximity switch	Optional board	DC 12 V; 10 mA
Relay (changeover) Contact rating Contact service life	Optional board	8 A at AC 240 V resistive load 100,000 operations at nominal load/350,000 operations at 3 A
Relay SPST (normally open) Contact rating Contact service life	Optional board	3 A at AC 240 V resistive load 350,000 operations at nominal load/900,000 operations at 1 A
Semiconductor relay Contact rating Protective circuit	Optional board	1 A at 240 V Varistor
PhotoMOS [®] relay	Optional board	$U \leq DC 45 V$ $U \leq AC 30 V$ $I \leq 200 mA$
Voltage Output signals Load resistance Accuracy	Optional board	0 to 10 V or 2 to 10 V $R_{load} \geq 500 \Omega$ $\leq 0.5 \%$
Electrical current Output signals Load resistance Accuracy	Optional board	0 to 20 mA or 4 to 20 mA $R_{load} \leq 500 \Omega$ $\leq 0.5 \%$

Display

Type	LC graphic display, blue with background lighting, 122 × 32 pixels
------	--

JUMO GmbH & Co. KG
 Delivery address: Mackenrodtstraße 14
 36039 Fulda, Germany
 Postal address: 36035 Fulda, Germany
 Phone: +49 661 6003-0
 Fax: +49 661 6003-607
 Email: mail@jumo.net
 Internet: www.jumo.net

JUMO Instrument Co. Ltd.
 JUMO House
 Temple Bank, Riverway
 Harlow, Essex CM 20 2DY, UK
 Phone: +44 1279 63 55 33
 Fax: +44 1279 62 50 29
 Email: sales@jumo.co.uk
 Internet: www.jumo.co.uk

JUMO Process Control, Inc.
 6733 Myers Road
 East Syracuse, NY 13057, USA
 Phone: +1 315 437 5866
 Fax: +1 315 437 5860
 Email: info.us@jumo.net
 Internet: www.jumousa.com



Electrical data

Voltage supply (switch-mode PSU)	AC 110 to 240 V +10/-15 %; 48 to 63 Hz or AC/DC 20 to 30 V; 48 to 63 Hz
Electrical safety	To DIN EN 61010, Part 1 overvoltage category II, pollution degree 2
Power consumption	Max. 14 VA (20 A fuse max.)
Data backup	EEPROM
Electrical connection	On the back via screw terminals, conductor cross-section up to max. 2.5 mm ²
Electromagnetic Compatibility (EMC) Interference emission Interference immunity	DIN EN 61326-1 Class A To industrial requirements

Enclosure

Enclosure type	Plastic enclosure for panel mounting to DIN IEC 61554 (indoor use)
Depth behind panel	90 mm
Ambient temperature	-5 to +55 °C
Storage temperature	-30 to +70 °C
Climatic rating	Rel. humidity ≤ 90 % annual mean, no condensation
Site altitude	Up to 2000 m above sea level
Operating position	Horizontal
Enclosure protection in panel case in surface-mounted case	To DIN EN 60529 Front IP65, rear IP20 IP65
Weight (fully fitted)	About 380 g

Interface

Modbus	
Interface type	RS422/RS485
Protocol	Modbus, Modbus Integer
Baud rate	9600, 19200, 38400
Device address	0 to 255
Max. number of nodes	32
PROFIBUS-DP	
Device address	0 to 255

Approvals/marks of conformity

Mark of conformity	Testing laboratory	Certificates/certification numbers	Test basis	valid for
c UL us	Underwriters Laboratories	E 201387	UL 61010-1 CAN/CSA-C22.2 No. 61010-1	Type 202553/01...

JUMO GmbH & Co. KG
 Delivery address: Mackenrodtstraße 14
 36039 Fulda, Germany
 Postal address: 36035 Fulda, Germany
 Phone: +49 661 6003-0
 Fax: +49 661 6003-607
 Email: mail@jumo.net
 Internet: www.jumo.net

JUMO Instrument Co. Ltd.
 JUMO House
 Temple Bank, Riverway
 Harlow, Essex CM 20 2DY, UK
 Phone: +44 1279 63 55 33
 Fax: +44 1279 62 50 29
 Email: sales@jumo.co.uk
 Internet: www.jumo.co.uk

JUMO Process Control, Inc.
 6733 Myers Road
 East Syracuse, NY 13057, USA
 Phone: +1 315 437 5866
 Fax: +1 315 437 5860
 Email: info.us@jumo.net
 Internet: www.jumousa.com



Electrical connection

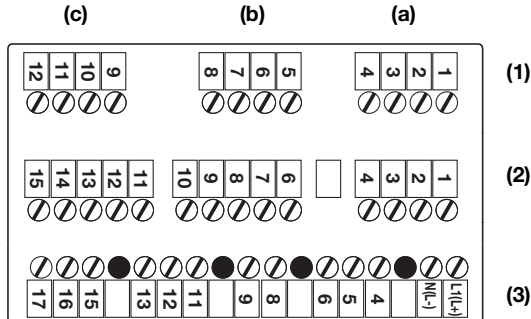

Mounting information for conductor cross-sections and ferrules

Ferrule	Conductor cross-section		Minimum ferrule length or stripping
	Minimum	Maximum	
Without ferrule	0.34 mm ²	2.5 mm ²	10 mm (stripping)
Without collar	0.25 mm ²	2.5 mm ²	10 mm
With collar up to 1.5 mm ²	0.25 mm ²	1.5 mm ²	10 mm
Twin, with collar	0.25 mm ²	1.5 mm ²	12 mm

(1)	Row 1	(a)	Option 1	(b)	Option 2	(c)	Option 3
(2)	Row 2	Main board (standard signal/resistance/temperature)					
(3)	Row 3	PSU board (voltage supply/2x relays)					

Optional board (row 1, slot a, b or c)

Function	Symbol	Terminal for slot (a)	Terminal for slot (b)	Terminal for slot (c)
Analog input				
Temperature sensor in a 2-wire circuit Pt100 or Pt1000		2 4	6 8	10 12
Temperature sensor in a 3-wire circuit Pt100 or Pt1000		2 3 4	6 7 8	10 11 12
Resistance transmitter		2 3 4	6 7 8	10 11 12
Electrical current		3 4	7 8	11 12
Voltage 0(2) to 10 V		1 2	5 6	9 10
Voltage 0 to 1 V		2 3	6 7	10 11
Continuous output				
Current or voltage		2 3	6 7	10 11
Modbus interface				
RS422		-	-	9 10 11 12
RS485		-	-	11 12

JUMO GmbH & Co. KG
 Delivery address: Mackenrodtstraße 14
 36039 Fulda, Germany
 Postal address: 36035 Fulda, Germany
 Phone: +49 661 6003-0
 Fax: +49 661 6003-607
 Email: mail@jumo.net
 Internet: www.jumo.net

JUMO Instrument Co. Ltd.
 JUMO House
 Temple Bank, Riverway
 Harlow, Essex CM 20 2DY, UK
 Phone: +44 1279 63 55 33
 Fax: +44 1279 62 50 29
 Email: sales@jumo.co.uk
 Internet: www.jumo.co.uk

JUMO Process Control, Inc.
 6733 Myers Road
 East Syracuse, NY 13057, USA
 Phone: +1 315 437 5866
 Fax: +1 315 437 5860
 Email: info.us@jumo.net
 Internet: www.jumousa.com



Function	Symbol	Terminal for slot (a)	Terminal for slot (b)	Terminal for slot (c)
PROFIBUS-DP interface				
	VP(+5V) RxD/TxD-P(B) RxD/TxD-N(A) DGND	-	-	9 10 11 12
Datalogger interface				
RS485	RxD/TxD+ RxD/TxD-	-	-	10 11
Relay (1x changeover)				
		K3 1 2 3	K4 5 6 7	K5 9 10 11
Relay (2x NO, common pin)				
		K3 1 2 K6 3	-	K5 9 10 K8 11
Triac (1 A)				
		K3 2 3	K4 6 7	K5 10 11
PhotoMOS[®] relay (0.2 A)				
		K3 1 2	K4 5 6	K5 9 10
		K6 3 4	K7 7 8	K8 11 12
Voltage supply for proximity switch				
		1 2	5 6	9 10

Main board (row 2)

Function	Symbol	Terminal
Standard signal input for electrical current 0(4) to 20 mA		3 4
Standard signal input for voltage 0(2) to 10 V or 10 to 0(2) V		1 2
Standard signal input for voltage 0 to 1 V		2 3
Temperature sensor in a 2-wire circuit Pt100 or Pt1000		2 3 4

JUMO GmbH & Co. KG
 Delivery address: Mackenrodtstraße 14
 36039 Fulda, Germany
 Postal address: 36035 Fulda, Germany
 Phone: +49 661 6003-0
 Fax: +49 661 6003-607
 Email: mail@jumo.net
 Internet: www.jumo.net

JUMO Instrument Co. Ltd.
 JUMO House
 Temple Bank, Riverway
 Harlow, Essex CM 20 2DY, UK
 Phone: +44 1279 63 55 33
 Fax: +44 1279 62 50 29
 Email: sales@jumo.co.uk
 Internet: www.jumo.co.uk

JUMO Process Control, Inc.
 6733 Myers Road
 East Syracuse, NY 13057, USA
 Phone: +1 315 437 5866
 Fax: +1 315 437 5860
 Email: info.us@jumo.net
 Internet: www.jumousa.com



Temperature sensor in a 3-wire circuit Pt100 or Pt1000		2 3 4
Temperature sensor in a 4-wire circuit Pt100 or Pt1000		1 2 3 4
Resistance transmitter		4 3 2
Binary inputs		
Binary input 1		6+ 10
Binary input 2		7+ 10

PSU board (row 3)

Function	Symbol	Terminal
Voltage supply for JUMO dTRANS 02		
Voltage supply: AC 110 to 240 V Voltage supply: AC/DC 20 to 30 V		1 L1 (L+) 2 N (L-)
n.c.		4 5 6
Voltage supply for external 2-wire transmitter		
DC 24 V (+20/-15 %)		8 L + 9 L -
Relay 1		
Switching output K1 (floating)		11 12 13
Relay 2		
Switching output K2 (floating)		15 16 17

JUMO GmbH & Co. KG
 Delivery address: Mackenrodtstraße 14
 36039 Fulda, Germany
 Postal address: 36035 Fulda, Germany
 Phone: +49 661 6003-0
 Fax: +49 661 6003-607
 Email: mail@jumo.net
 Internet: www.jumo.net

JUMO Instrument Co. Ltd.
 JUMO House
 Temple Bank, Riverway
 Harlow, Essex CM 20 2DY, UK
 Phone: +44 1279 63 55 33
 Fax: +44 1279 62 50 29
 Email: sales@jumo.co.uk
 Internet: www.jumo.co.uk

JUMO Process Control, Inc.
 6733 Myers Road
 East Syracuse, NY 13057, USA
 Phone: +1 315 437 5866
 Fax: +1 315 437 5860
 Email: info.us@jumo.net
 Internet: www.jumousa.com



Dimensions

Panel case

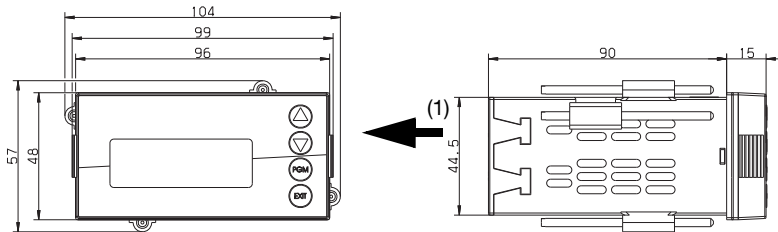

Close mounting

Minimum spacing of panel cutouts	Horizontal	Vertical
Without setup connector	30 mm	11 mm
With setup connector (see arrow)	65 mm	11 mm

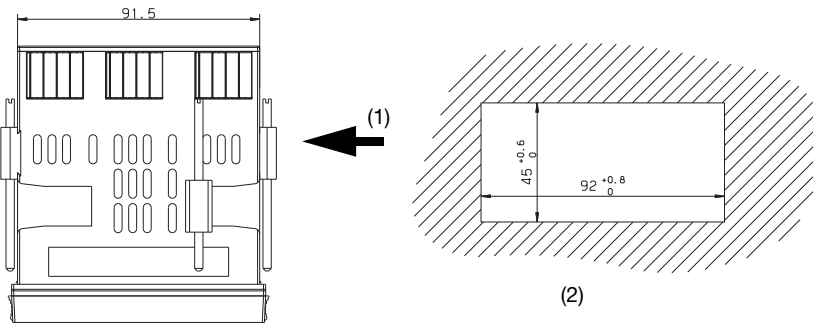

- (1) PC interface socket
- (2) Panel cutout to DIN IEC 61554: 2002-08

Surface-mounted case

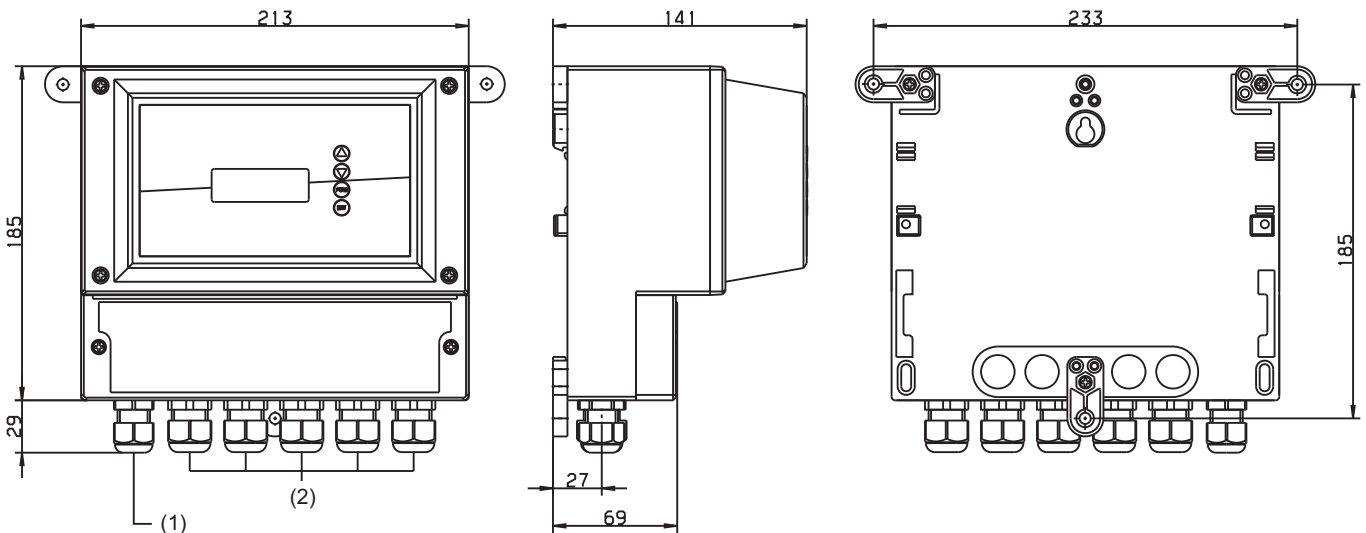

- (1) Cable gland M16
- (2) Cable gland M20

JUMO GmbH & Co. KG
 Delivery address: Mackenrodtstraße 14
 36039 Fulda, Germany
 Postal address: 36035 Fulda, Germany
 Phone: +49 661 6003-0
 Fax: +49 661 6003-607
 Email: mail@jumo.net
 Internet: www.jumo.net

JUMO Instrument Co. Ltd.
 JUMO House
 Temple Bank, Riverway
 Harlow, Essex CM 20 2DY, UK
 Phone: +44 1279 63 55 33
 Fax: +44 1279 62 50 29
 Email: sales@jumo.co.uk
 Internet: www.jumo.co.uk

JUMO Process Control, Inc.
 6733 Myers Road
 East Syracuse, NY 13057, USA
 Phone: +1 315 437 5866
 Fax: +1 315 437 5860
 Email: info.us@jumo.net
 Internet: www.jumousa.com



Application examples

Indicator/controller for pH (temperature compensation)

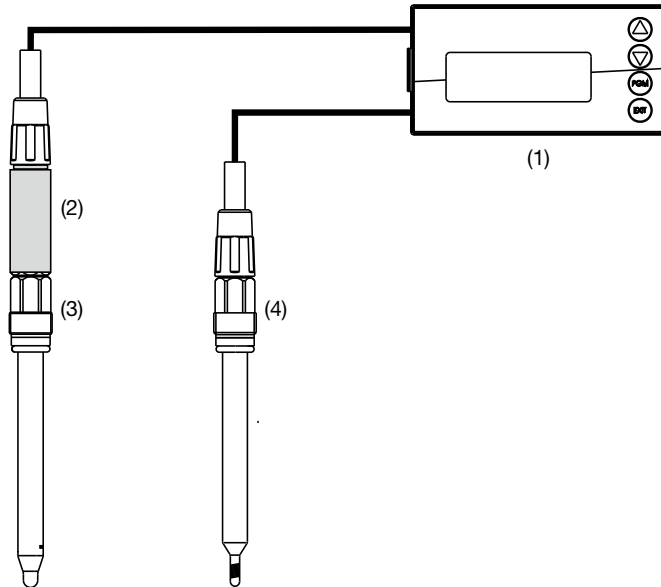

- (1) JUMO dTRANS AS 02
- (2) JUMO digiLine pH with analog output type 202705
- (3) pH combination electrode
- (4) Compensation thermometer, type 201085

Indicator/controller for free chlorine, chlorine dioxide, hydrogen peroxide, peracetic acid or ozone (with flow monitoring)

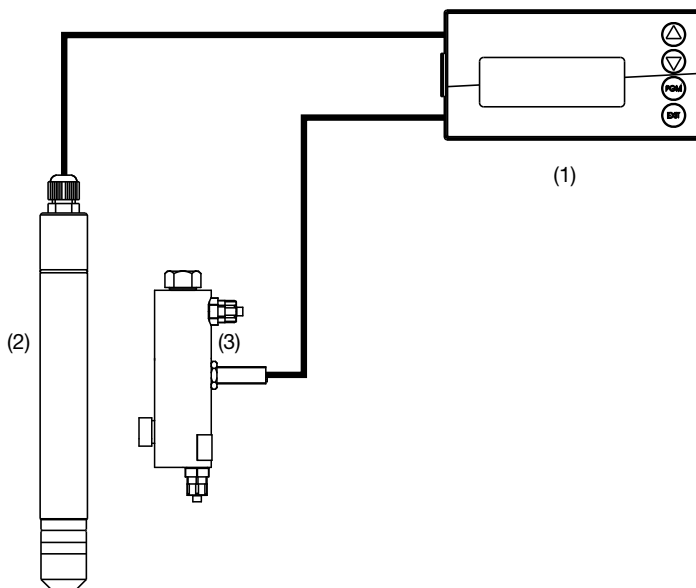

- (1) JUMO dTRANS AS 02
- (2) Measuring cell for free chlorine, type 202630
- (3) Flow monitor, type 202811/20

JUMO GmbH & Co. KG
Delivery address: Mackenrodtstraße 14
36039 Fulda, Germany
Postal address: 36035 Fulda, Germany
Phone: +49 661 6003-0
Fax: +49 661 6003-607
Email: mail@jumo.net
Internet: www.jumo.net

JUMO Instrument Co. Ltd.
JUMO House
Temple Bank, Riverway
Harlow, Essex CM 20 2DY, UK
Phone: +44 1279 63 55 33
Fax: +44 1279 62 50 29
Email: sales@jumo.co.uk
Internet: www.jumo.co.uk

JUMO Process Control, Inc.
6733 Myers Road
East Syracuse, NY 13057, USA
Phone: +1 315 437 5866
Fax: +1 315 437 5860
Email: info.us@jumo.net
Internet: www.jumousa.com



Indicator/controller for level or liquid level measurement

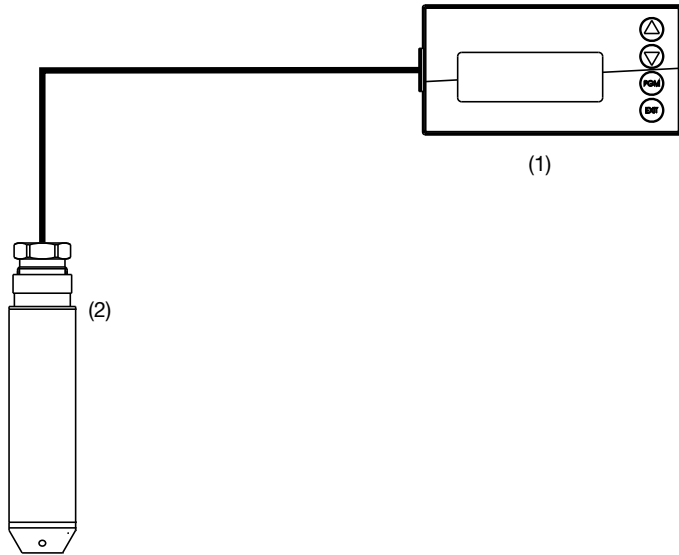

- (1) JUMO dTRANS AS 02
- (2) Level measurement probe, type 402090 or type 404391

JUMO GmbH & Co. KG

Delivery address: Mackenrodtstraße 14
36039 Fulda, Germany
Postal address: 36035 Fulda, Germany
Phone: +49 661 6003-0
Fax: +49 661 6003-607
Email: mail@jumo.net
Internet: www.jumo.net

JUMO Instrument Co. Ltd.

JUMO House
Temple Bank, Riverway
Harlow, Essex CM 20 2DY, UK
Phone: +44 1279 63 55 33
Fax: +44 1279 62 50 29
Email: sales@jumo.co.uk
Internet: www.jumo.co.uk

JUMO Process Control, Inc.

6733 Myers Road
East Syracuse, NY 13057, USA
Phone: +1 315 437 5866
Fax: +1 315 437 5860
Email: info.us@jumo.net
Internet: www.jumousa.com

**Order details**

(1) Basic type	
202553/01	JUMO dTRANS AS 02 - Transmitter/controller for standard signals and temperature in panel case, 96 mm x 48 mm (front IP65)
202553/05	JUMO dTRANS AS 02 - Transmitter/controller for standard signals and temperature in surface-mounted case (IP65)
(2) Version	
8	Standard with factory setting
9	Programming to customer specification
(3) Operating language	
01	German
02	English
(4) Optional slot 1	
0	Not used
1	Analog input
2	Relay (changeover)
3	2 Relay (normally open)
4	Analog output
5	2 PhotoMOS [®] relays
6	Solid state relay 1 A
7	Voltage supply output DC ±5 V
8	Voltage supply output DC 12 V
(5) Optional slot 2	
0	Not used
1	Analog input
2	Relay (changeover)
3	2 Relay (normally open)
4	Analog output
5	2 PhotoMOS [®] relays
6	Solid state relay 1 A
7	Voltage supply output DC ±5 V
8	Voltage supply output DC 12 V
(6) Option für Steckplatz 3	
0	Not used
1	Analog input
2	Relay (changeover)
3	2 Relay (normally open)
4	Analog output
5	2 PhotoMOS [®] relays
6	Solid state relay 1 A
7	Voltage supply output DC ±5 V
8	Voltage supply output DC 12 V
10	Interface RS422/485
11	Data logger with interface RS422/485
12	PROFIBUS-DP interface
(7) Voltage supply	
23	AC 110 to 230 V, +10/-15 %, 48 to 63 Hz
25	AC/DC 20 to 30 V, 48 to 63 Hz

Order code (1) (2) (3) (4) (5) (6) (7)
 Order example 202553/01 - 8 - 01 - 2 - 2 - 4 - 23

JUMO GmbH & Co. KG
 Delivery address: Mackenrodtstraße 14
 36039 Fulda, Germany
 Postal address: 36035 Fulda, Germany
 Phone: +49 661 6003-0
 Fax: +49 661 6003-607
 Email: mail@jumo.net
 Internet: www.jumo.net

JUMO Instrument Co. Ltd.
 JUMO House
 Temple Bank, Riverway
 Harlow, Essex CM 20 2DY, UK
 Phone: +44 1279 63 55 33
 Fax: +44 1279 62 50 29
 Email: sales@jumo.co.uk
 Internet: www.jumo.co.uk

JUMO Process Control, Inc.
 6733 Myers Road
 East Syracuse, NY 13057, USA
 Phone: +1 315 437 5866
 Fax: +1 315 437 5860
 Email: info.us@jumo.net
 Internet: www.jumousa.com



Stock version

(delivery 3 working days after receipt of order)

Order code	Part no.
202553/01-8-01-4-0-0-23/000	00550842

Accessories

(delivery 10 working days after receipt of order)

Item	Part no.
Holder for C rail (PG 709710)	00375749
Dummy cover 96 mm × 48 mm (PG 709710)	00069680
Pipe mounting set (PG 209791)	00398162
Weather protection roof complete for basic type extension 05 (PG 209791)	00401174
PC setup software (PG 202599)	00560380
PC interface cable including USB/TTL converter and two adapters (USB connecting cable) (PG 709720)	00456352

Optional board	Code	Part no.
Analog input (universal)	1	00442785
Relay (1× changeover)	2	00442786
Relay (2× NO)	3	00442787
Analog output	4	00442788
2 PhotoMOS [®] relay	5	00566677
Solid state relay 1 A	6	00442790
Supply voltage output DC ±5 V (e.g. for ISFET)	7	00566681
Supply voltage output DC 12 V (e.g. for inductive proximity switch)	8	00566682
Interface RS422/485	10	00442782
Datalogger with RS485 interface	11	00566678
PROFIBUS-DP interface	12	00566679